**User's
Manual**

**CA500, CA550
Multifunction Process
Calibrator
Getting Started Guide**

Product Registration

Thank you for purchasing YOKOGAWA products.

YOKOGAWA provides registered users with a variety of information and services.

Please allow us to serve you best by completing the product registration form accessible from our homepage.

<http://tmi.yokogawa.com/>

Thank you for purchasing the CA500/CA550 Multifunction Process Calibrator. This Getting Started Guide focuses on the handling precautions, basic operations, and specifications of the CA500 and CA550.

To ensure correct use, please read this manual thoroughly before operation. Keep this manual in a safe place for quick reference.

List of Manuals

The following three manuals, including this one, are provided as manuals for the CA500 and CA550.

Please read all manuals.

Manual Title	Manual No.	Description
CA500, CA550 Multifunction Process Calibrator User's Manual	IM CA500-01EN	The supplied CD contains the PDF file of this manual. This manual explains the instrument's standard features and how to use these features.
CA500, CA550 Multifunction Process Calibrator Getting Started Guide	IM CA500-02EN	This document. This guide explains the handling precautions, basic operations, and specifications of this instrument.
CA500, CA550 Multifunction Process Calibrator User's Manual	IM CA500-92Z1	A manual for China.
“전기용품 및 생활용품 안전관리법” 관련일차전지에 대한 대응	PIM 902-01KO	A manual for Korea.

The “-EN”, “-Z1”, and “KO” in the manual number are the language code.

Contact information of Yokogawa offices worldwide is provided on the following sheet.

Manual No.	Description
PIM113-01Z2	List of worldwide contacts

Notes

- The contents of this manual are subject to change without prior notice as a result of continuing improvements to the instrument's performance and functions. The figures given in this manual may differ from those that actually appear on your screen.
- Every effort has been made in the preparation of this manual to ensure the accuracy of its contents. However, should you have any questions or find any errors, please contact your nearest YOKOGAWA dealer.
- Copying or reproducing all or any part of the contents of this manual without the permission of YOKOGAWA is strictly prohibited.

Trademarks

- Adobe and Acrobat are either registered trademarks or trademarks of Adobe Systems Incorporated.
- HART is a registered trademark of FieldComm Group.
- In this manual, the ® and TM symbols do not accompany their respective registered trademark or trademark names.
- Company and product names are trademarks or registered trademarks of their respective holders.

Revisions

1st Edition: October 2019

2nd Edition: September 2020

Checking the Contents of the Package

To prevent condensation, before opening the package, allow it to adjust to the ambient temperature. In particular, if you move the package from a cool location to a hot location, allow it to adjust to the ambient temperature for at least an hour before opening the package.

Unpack the box, and check the following before operating the instrument. If the wrong items have been delivered, if items are missing, or if there is a problem with the appearance of the items, contact your nearest YOKOGAWA dealer.

CA500/CA550

Check that the product that you received is what you ordered by referring to the model name on the name plate on the rear panel of the main unit. For reference, the model name and specifications of the products are listed below.

MODEL	Suffix Code*	Description
CA500	-F1**	Multifunction process calibrator
CA550		Multifunction process calibrator (with HART communication function)
	-F2***	HART/BRAIN (CA550 only)
	-F3***	HART (CA550 only)

* For products whose suffix code contains "Z," an exclusive manual may be included. Please read it along with the standard manual.

** A model without either the HART or BRAIN communication function. This suffix code is always added for the CA500.

*** Either F2 or F3 is always added for the CA550.
Please contact your dealer for sales area.

No. (Instrument number)

When contacting the dealer from which you purchased the instrument, please give them the instrument number.

Standard Accessories

The following accessories are included. Check that all contents are present and undamaged.

No	Name	Model or Part No.	Quantity	Notes
1	Lead cable for source	98020	1 set	1 red, 2 black, 1.7 m 7 mm fork terminal to alligator clip
2	Source/measurement lead cable	98035	1 pc.	3 red, 1 black, 1.7 m L plug terminal to alligator clip
3	Binding post (red-black pair)*	99045	1 set	One short plate included
4	Binding post (red-red pair)*	99046	1 set	One short plate included
5	USB cable	A1421WL	1 pc.	USB Type A to Type B, 2 m
6	Shoulder strap	B8070CY	1 pc.	
7	Soft case	B8080FQ	1 pc.	For accessories
8	Batteries	-	4 pcs.	AA alkaline batteries (LR6)
9	CD	A1031US	1 copy	User's Manual (PDF)
10	Manuals	IM CA500-02EN IM CA500-92Z1 PIM 902-01KO PIM 113-01Z2	1 copy each	This manual. A manual for China. A manual for Korea. Not Included depending on the specifications. List of contacts

* Before using the included binding post, remove the short plate attached to the binding post.

Standard accessories are not covered by warranty.

Manual CD

The English folder in the CD contains the PDF files shown below. The CD also contains Japanese manuals.

File Name	Manual Title	Manual No.
CA500,CA550 Users_manual.pdf	CA500, CA550 Multifunction Process Calibrator User's Manual	IM CA500-01EN

To view the above PDF data, you need Acrobat Reader or a software application that can open PDF.

Optional Accessories (Sold separately)

The optional accessories below are available for purchase separately. For information about ordering accessories, contact your nearest YOKOGAWA dealer.

Item	Model	Min. Q'ty	Specifications
Lead cable	98064	1	1 red, 1 black, 1.7 m L plug terminal to alligator clip
Grabber clip	98026	1	1 red-black pair, 2 m, separate type
RJ sensor	90080	1	Pt100 JIS AA class or equivalent, Thermometer operating temperature range: -10°C to +55°C 8-polar miniDin connector, 1.5 m shielded cable Fork terminal (M3 terminal block compatible)
Thermocouple Mini Plug Set 1	90040	1	K (yellow)/ E (violet)/ J (black)/ T (blue)/R•S (green)/ B•U (white)/ G (red, green)/D (red, white)/ C (red)/ N (orange)
Thermocouple Mini Plug Set 2	90045	1	K (yellow)/ E (violet)/ J (black)/ T (blue)
Soft Carrying Case	SU2006A	1	

* Accessories (sold separately) are not covered by warranty.

Conventions Used in This Guide

Prefixes k and K

This manual distinguishes prefixes k and K used before units as follows:

k: Denotes 1000. Example: 100 kS/s (sample rate)

K: Denotes 1024. Example: 720 KB (file size)

Displayed Characters

Bold characters in procedural explanations are used to indicate panel keys and soft keys that are used in the procedure and menu items that appear on the screen.

Notes and Cautions

The notes and cautions in this guide are categorized using the following symbols.



Improper handling or use can lead to injury to the user or damage to the instrument. This symbol appears on the instrument to indicate that the user must refer to the user's manual for special instructions. The same symbol appears in the corresponding place in the user's manual to identify those instructions. In the manual, the symbol is used in conjunction with the word "WARNING" or "CAUTION."

WARNING

Calls attention to actions or conditions that could cause serious or fatal injury to the user, and precautions that can be taken to prevent such occurrences.

CAUTION

Calls attention to actions or conditions that could cause light injury to the user or damage to the instrument or user's data, and precautions that can be taken to prevent such occurrences.

Note

Calls attention to information that is important for the proper operation of the instrument.

French



Une manipulation ou une utilisation incorrectes risquent de blesser l'utilisateur ou d'endommager l'instrument. Ce symbole apparaît sur l'instrument pour indiquer à l'utilisateur qu'il doit se reporter au manuel de l'utilisateur afin d'y lire les instructions spécifiques correspondantes. Ce même symbole apparaît à la section correspondante du manuel de l'utilisateur pour signaler lesdites instructions. Dans le manuel de l'utilisateur, ce symbole est accompagné des termes AVERTISSEMENT et ATTENTION.

AVERTISSEMENT

Attire l'attention sur des gestes ou des conditions susceptibles de provoquer des blessures graves (voire mortelles), et sur les précautions de sécurité pouvant prévenir de tels accidents.

ATTENTION

Attire l'attention sur des gestes ou des conditions susceptibles de provoquer des blessures légères ou d'endommager l'instrument ou les données de l'utilisateur, et sur les précautions de sécurité susceptibles de prévenir de tels accidents.

Safety Precautions

This product is designed to be used by a person with specialized knowledge. The general safety precautions described herein must be observed during all phases of operation. If the product is used in a manner not specified in this guide, the protection provided by the product may be impaired. YOKOGAWA assumes no liability for the customer's failure to comply with these requirements.

This manual is part of the product and contains important information. Store this manual in a safe place close to the instrument so that you can refer to it immediately. Keep this manual until you dispose of the instrument.

The following symbols are used on this instrument.



Handle with care. Refer to the user's manual or service manual. This symbol appears on dangerous locations on the instrument which require special instructions for proper handling or use. The same symbol appears in the corresponding place in the manual to identify those instructions.



Direct current



Functional ground

French



À manipuler délicatement. Toujours se reporter aux manuels d'utilisation et d'entretien. Ce symbole a été apposé aux endroits dangereux de l'instrument pour lesquels des consignes spéciales d'utilisation ou de manipulation ont été émises. Le même symbole apparaît à l'endroit correspondant du manuel pour identifier les consignes qui s'y rapportent.



Courant direct



Borne de terre fonctionnelle

Failure to comply with the precautions below could lead to injury or death or damage to the instrument.

WARNING

Use the Instrument Only for Its Intended Purpose

This instrument sources and measures DC voltage and DC current. Use this instrument only for these purposes.

Check the Physical Appearance

Do not use the instrument if there is a problem with its physical appearance.

Batteries

- Do not mix new and old batteries or mix different brands or types of batteries. The batteries may leak, heat up, or burst due to their characteristic differences.
- Never replace the batteries with the main unit turned on.

Do Not Operate in an Explosive Atmosphere

Do not use this instrument in the presence of flammable gases or vapors. Doing so is extremely dangerous.

Do Not Remove the Covers or Disassemble or Alter the Instrument

Only qualified YOKOGAWA personnel may remove the covers and disassemble or alter the instrument.

The inside of the instrument is dangerous because parts of it have high voltages.

Measurement Category

The measurement category of this instrument's signal input terminals is Other (O). Do not use it to measure the main power supply or for Measurement Categories II, III, and IV.

Install or Use the Instrument in Appropriate Locations

- This instrument is not dust-proof or water-proof. Do not install or use this instrument outdoors, in a location subject to rain or water, or a location full of dust.
- Install the instrument so that you can immediately turn off the power if an abnormal or dangerous condition occurs.

External Connections

Before connecting the instrument to the DUT or external control circuit or before touching a circuit, turn off its power and check that it has no voltage. To prevent electric shock and accidents, connect the ground of the probes or input connectors to the ground potential of the device under measurement.

Handling

- Never use the instrument if the instrument or your hand is wet or when condensation or other water droplets are on the instrument.
- Never open the battery cover while a measurement is in progress.

Signal Input

Do not apply signals that exceed the measurement range.

Lead cable

- Use the probes supplied by Yokogawa for this instrument.
- Do not use deteriorated or damaged lead cables.
- Check the conduction of the lead cable before using it.
- Do not use the lead cable for source (98020) to make measurements.

When making a measurement, be sure to use the source/measurement lead cable (98035).

Accessories

- Use the accessories specified in this manual. Moreover, use the accessories of this product only with Yokogawa products that specify them as accessories.
- Use the accessories of this product within the rated range of each accessory. When using several accessories together, use them within the specification range of the accessory with the lowest rating.
- Do not use faulty accessories.

Damaged Cable

If the cable is torn and the inner metal is exposed or if a color different from the outer sheath appears, stop using the cable immediately.

CD

Never play this CD, which contains the user's manuals, in an audio CD player. Doing so may cause loss of hearing or speaker damage due to the high-volume sound that may be produced.

CAUTION

Operating Environment Limitations

This product is classified as Class A (for use in industrial environments). Operation of this product in a residential area may cause radio interference, in which case the user will be required to correct the interference.

Operating Environment

This instrument is not dust-proof or water-proof.

French

AVERTISSEMENT

Ne faites de cet équipement que l'utilisation pour laquelle il a été conçu

Cet équipement est un calibre pour l'équipement de mesure de tension/courant, pour l'équipement de thermocouple/mesure et pour l'équipement de RTD/mesure. Utilisez cet équipement à des fins de calibrage uniquement.

Inspecter l'apparence physique

Ne pas utiliser l'instrument si son intégrité physique semble être compromise.

Batteries

- Ne pas mélanger des batteries neuves et des batteries usagées, ni des batteries de marques ou de types différents. Les batteries risquent de fuir, de chauffer ou d'éclater en raison de leurs différentes caractéristiques.
- Ne jamais remplacer les batteries lorsque la mesure est en cours.

Ne pas utiliser dans un environnement explosif

Ne pas utiliser l'instrument en présence de gaz ou de vapeurs inflammables. Cela pourrait être extrêmement dangereux.

Ne pas retirer le capot, ni démonter ou modifier l'instrument

Seul le personnel YOKOGAWA qualifié est habilité à retirer le capot et à démonter ou modifier l'instrument. Certains composants à l'intérieur de l'instrument sont à haute tension et par conséquent, représentent un danger.

Catégorie de mesure

La catégorie de mesure des terminaux d'entrée de signal de ce produit est Autre(O). Ne pas l'utiliser pour mesurer l'alimentation électrique, ni pour les catégories de mesure II, III et IV.

Installer et utiliser l'instrument aux emplacements appropriés

- Cet instrument n'est pas étanche à la poussière ni à l'eau. Ne pas installer, ni utiliser cet instrument à l'extérieur, dans un endroit exposé à la pluie ou à l'eau, ou dans un endroit poussiéreux.
- Installer l'instrument de manière à pouvoir immédiatement le débrancher du secteur en cas de fonctionnement anormal ou dangereux

Connexions Externes

Avant de brancher cet instrument au dispositif en essai (DUT) ou au circuit de commande externe, ou avant de toucher un circuit, mettre l'instrument hors tension et vérifier l'absence de tension. Pour éviter un choc électrique ou des accidents, brancher la terre des sondes ou les connecteurs d'entrée au potentiel de terre de l'appareil faisant l'objet de la mesure.

Manipulation

- Ne jamais utiliser cet instrument si l'instrument ou votre main est mouillé, ou la condensation ou la goutte d'eau sont adhérentes à l'instrument.
- Ne jamais ouvrir le couvercle de batterie pendant la mesure est en cours.

Signal d'Entrée

Ne pas appliquer de signaux qui dépassent la plage de mesure.

Câble de Raccordement

- Utiliser les sondes fournies par Yokogawa pour cet instrument.
- Ne pas utiliser des câbles de raccordement détériorés ou endommagés.
- Vérifier la conduction de câble de raccordement avant l'utiliser.
- Ne pas utiliser le câble de raccordement pour la source (98020) pour faire des mesures.
Lors de la mesure, veiller à utiliser le câble de raccordement de la source/mesure (98035).

Accessoires

- Utiliser les accessoires spécifiés dans ce manuel. En outre, utiliser les accessoires de ce produit uniquement avec des produits Yokogawa pour lesquels ils sont spécifiés comme accessoires.
- Utiliser les accessoires de ce produit dans la plage nominale de chaque accessoire. Lors de l'utilisation de plusieurs accessoires ensemble, les utiliser dans la plage spécifiée de l'accessoire avec la tension nominale la plus basse.
- Ne pas utiliser d'accessoires défectueux.

Câble de signal endommagé

Si le câble de signal est déchiré et que le métal intérieur est exposé ou si une couleur différente de la gaine externe est visible, arrêter immédiatement d'utiliser ce câble.

CD

Ce CD contient les manuels d'utilisation. Ne jamais insérer ce CD dans un lecteur de CD audio. Cela pourrait entraîner une perte d'audition ou l'endommagement des enceintes en raison du volume potentiellement élevé des sons produits.

ATTENTION

Limitations relatives à l'environnement opérationnel

Ce produit est un produit de classe A (pour environnements industriels). L'utilisation de ce produit dans un zone résidentielle peut entraîner une interférence radio que l'utilisateur sera tenu de rectifier.

Environnement Opérationnel

Cet instrument n'est pas étanche à la poussière ni à l'eau.

Regulations and Sales in Each Country or Region —

Waste Electrical and Electronic Equipment



Waste Electrical and Electronic Equipment (WEEE), Directive

(This directive is valid only in the EU.)

This product complies with the WEEE directive marking requirement. This marking indicates that you must not discard this electrical/electronic product in domestic household waste.

Product Category

With reference to the equipment types in the WEEE directive, this product is classified as a “Monitoring and control instruments” product.

When disposing products in the EU, contact your local Yokogawa office in Europe.

Do not dispose in domestic household waste.

EU Battery Directive

(This directive is valid only in the EU.)



Batteries are included in this product. This marking indicates they shall be sorted out and collected as ordained in EU Battery Directive.

Battery type:

1. Lithium battery

You cannot replace batteries by yourself. When you need to replace batteries, contact your local Yokogawa office in Europe.

2. Alkaline battery

When disposing of alkaline batteries, follow the domestic law concerning disposal. Take the proper action to dispose batteries in accordance with the established collection system in the European Economic Area. For the battery removal procedure, see page 31.

Authorized Representative in the EEA

Yokogawa Europe B.V. is the authorized representative of Yokogawa Test & Measurement Corporation for this product in the EEA. To contact Yokogawa Europe B.V., see the separate list of worldwide contacts, PIM 113-01Z2.

Disposing of the Instrument

When disposing of the instrument, follow the laws and ordinances of your country or region.

Contents

Product Registration.....	i
Checking the Contents of the Package.....	3
Conventions Used in This Guide.....	6
Safety Precautions.....	8
Regulations and Sales in Each Country or Region.....	13
1 Component Names and Functions	
1.1 Front Panel.....	15
1.2 Side Panel and Rear Panel.....	17
1.3 Display.....	18
2 Preparation before Use	
2.1 Handling Precautions.....	21
2.2 Installing the Instrument.....	23
2.3 Connecting Cables.....	26
2.4 Loading and Removing Batteries.....	32
2.5 Supplying Power through the USB Terminal.....	34
2.6 Turning the Power On and Off.....	35
2.7 Setting the Date and Time.....	36
3 Common Operations	
3.1 Opening and Closing Setup Screens.....	38
3.2 Setup Screen Operation.....	38
3.3 Selection Menu Operation.....	39
3.4 Specifying Values.....	39
3.5 Setting Alphanumeric Characters.....	40
4 Troubleshooting, Maintenance, and Inspection	
4.1 Troubleshooting.....	41
4.2 Error Codes, Error Messages, and Corrective Actions.....	42
4.3 Displaying Instrument Information.....	43
4.4 Recommended Replacement Parts, Consumable Parts, Calibration and Adjustment.....	44
5. Specifications	
5.1 DC Voltage, DC Current, Resistance and Pulse Source.....	45
5.2 DC Voltage, DC Current, Resistance and Pulse Measurement.....	47
5.3 Temperature Measurement (TC) and Thermocouple Calibration Voltage Source...	49
5.4 Temperature Measurement (RTD) and Resistance Source for RTD Calibration.....	62
5.5 Common Specifications.....	65
5.6 General Specifications.....	66

1 Component Names and Functions

1.1 Front Panel

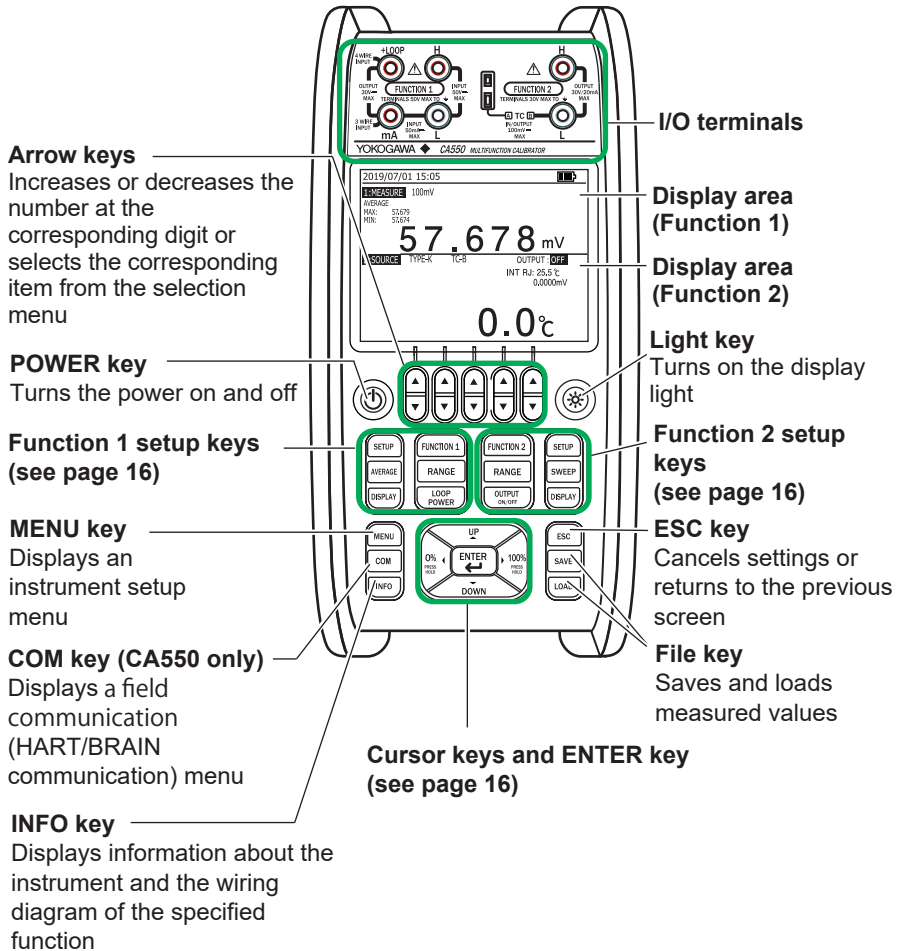

Function Set Keys

Function 1 setup keys

Sets the 0 and 100% value and the pulse contact input on/off

Turns on/off the moving average function and the max/min display

Turns on/off the 0 and 100% value displays and selects whether to show the measured value or percentage on the main display

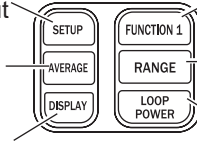

Selects the measurement function (voltage, current, resistance, RTD, pulse, off)

Selects the measurement range

Turns on and off the loop power supply (when current is being measured)

Function 2 setup keys

Selects thermocouple measurement and source function (voltage, current, resistance, RTD, pulse, thermocouple, off)

Selects the source range

Turns the source on or off

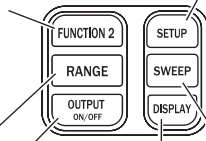

Sets the 0 and 100% value, number of divisions, sweep settings, temperature measurement/source items (thermocouple terminal selection, burnout, etc.), and pulse source items (amplitude, pulse count, pulse contact output on/off)

Selects the sweep to be executed (linear, step, program)

Turns on and off the 0 and 100% value displays and selects whether to show the source value or percentage on the main display

Cursor Keys and ENTER Key

On screens displaying the source value, the following functions can be executed.

Steps up the source value according to the specified number of divisions

Sets the source value to the 0% value. To set the 0% value, hold down the key. The displayed source value is set to 0%.

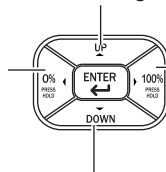

Sets the source value to the 100% value. To set the 100% value, hold down the key. The displayed source value is set to 100%.

Steps down the source value according to the specified number of divisions

On various setup menus, use the cursor keys to select settings and the ENTER key to confirm the settings.

1.2 Side Panel and Rear Panel

Side panel

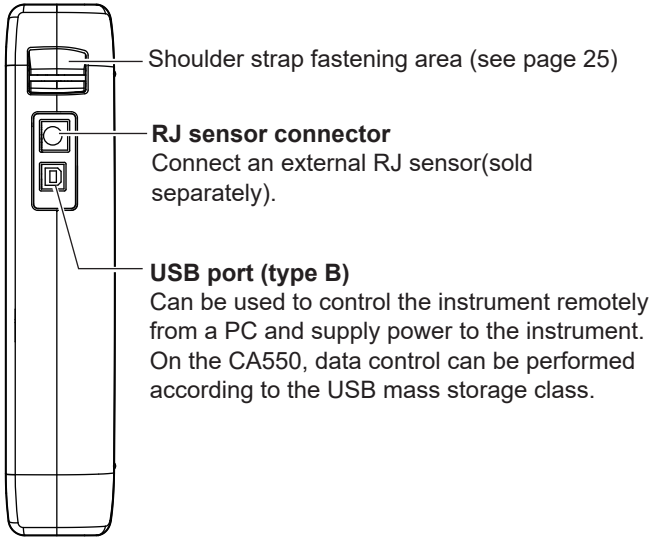

Rear Panel

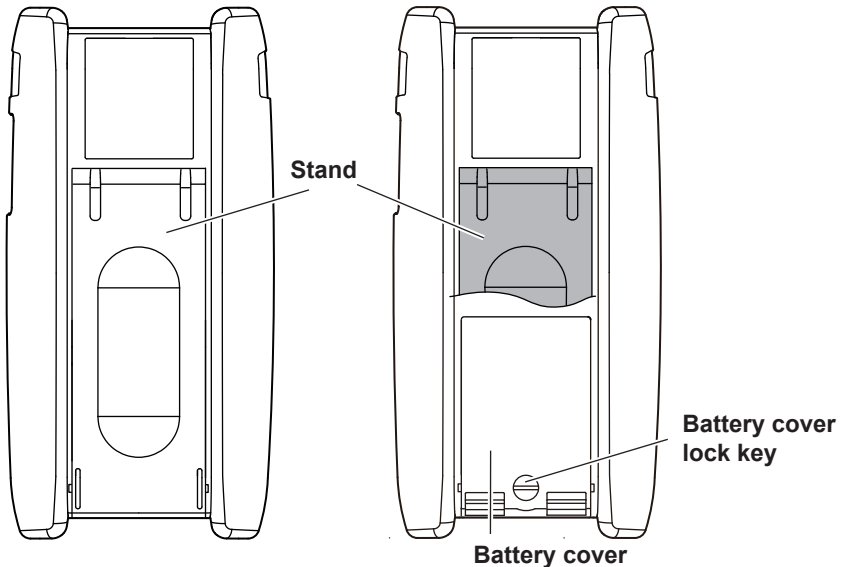

1.3 Display

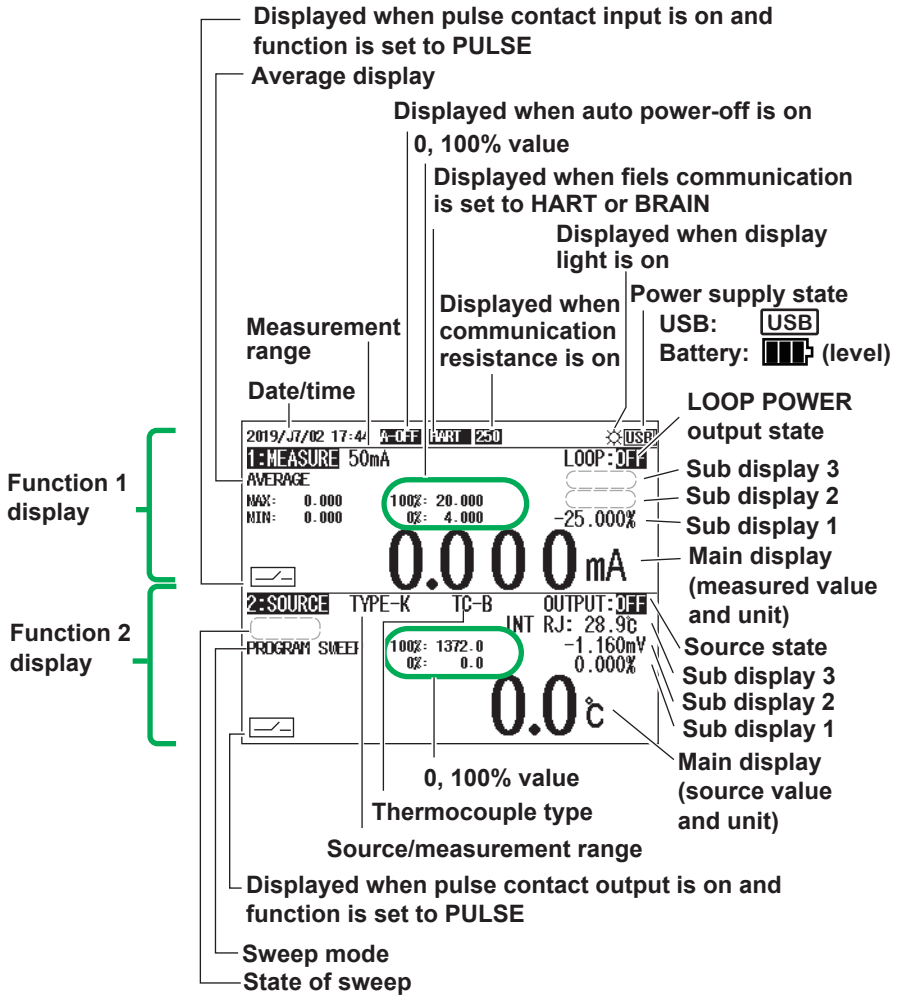

Function 1 and 2 Displays

The top area of the screen shows the function 1 information and the bottom area the function 2 information.

Main Displays and Sub Displays

Each time you press the DISPLAY key of function 1 or 2, the main display switches between showing the physical value and percentage. When the main display is showing the physical value, sub display 1 shows the percentage, and vice versa. Sub display 2 shows the thermoelectromotive force of a thermocouple, the resistance of an RTD.

Sub display 3 shows the temperature of a reference junction or the amplitude voltage.

The 0% and 100% values can be shown or hidden using DISPLAY.

Function	Main display	Sub display 1	Sub display 2	Sub display 3
DC voltage	Measure value/ source value	Percentage	—	—
	Percentage	Measure value/ source value	—	—
DC current	Measure value/ source value	Percentage	—	—
	Percentage	Measure value/ source value	—	—
Resistance	Measure value/ source value	Percentage	—	—
	Percentage	Measure value/ source value	—	—
Thermocouple	Measure value/ source value (temperature)	Percentage	Measure value/ source value (voltage)	Temperature monitor (reference junction temperature)
	Percentage	Measure value/ source value (temperature)	Measure value/ source value (voltage)	Temperature monitor (reference junction temperature)
RTD	Measure value/ source value (temperature)	Percentage	Measure value/ source value (resistance)	—
	Percentage	Measure value/ source value (temperature)	Measure value/ source value (resistance)	—
Frequency	Measure value/ source value	Percentage	—	—
	Percentage	Measure value/ source value	—	—

Select Menu

When setting a function, available options are displayed at the bottom of the screen. Press the arrow key corresponding to the option you want to select.

For two-row selection menus, the up arrow key corresponds to the top area and the down arrow key to the bottom area.

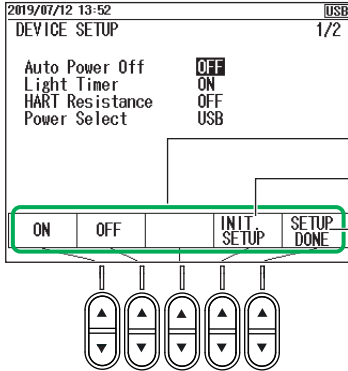

Select menu

Initializes the settings

Confirms the settings and closes the setup screen

2 Preparation before Use

2.1 Handling Precautions

Safety Precautions

If you are using this instrument for the first time, make sure to thoroughly read the safety precautions given on pages 8 to 12.

Unplug If Abnormal Behavior Occurs

If you notice smoke or unusual odors coming from the instrument, immediately turn off the power, remove the batteries if possible, and contact your nearest YOKOGAWA dealer. Also, turn off the power to source/measurement targets that are connected to the input terminals.

Do Not Remove the Case

Do not remove the case from the instrument. Some parts of the instrument use high voltages and are extremely dangerous. For internal inspection and adjustment, contact your nearest YOKOGAWA dealer.

Operating Environment and Conditions

This instrument complies with the EMC standard under specific operating environment and operating conditions. If the installation, wiring, and so on are not appropriate, the compliance conditions of the EMC standard may not be met. In such cases, the user will be required to take appropriate measures.

General Handling Precautions

Do Not Place Objects on Top of the Instrument

Never place other instruments or objects containing water on top of the instrument, otherwise a breakdown may occur.

Do Not Subject the Inputs and Outputs to Mechanical Shock

If the input connectors or adapters are subjected to mechanical shock, they may be damaged. The instrument may not perform measurements correctly due to damage or deformation that is not visible to the naked eye.

Do Not Damage the LCD

Because the LCD can be easily scratched, do not allow any sharp objects near it. In addition, observe the following:

- Do not apply vibration or shock.
- Do not apply strong shock to the LCD.
- Do not place objects on the LCD.

Remove the Batteries during Extended Non-Use

Remove the batteries from the main unit.

When Carrying the Instrument

First, turn off the device under measurement. Next, turn off the instrument.

When USB power supply is in use, remove the USB cable. Then, remove all the cables.

Attaching the Shoulder Strap

Attach the shoulder belt to prevent dropping the instrument. For instructions on how to attach the shoulder strap, see page 25.

When Cleaning the Instrument

When cleaning the case or the operation panel, gently wipe the outer surface using a damp, well-wrung, soft, clean cloth. The instrument can malfunction if water enters inside the instrument.

Do not use chemicals such as benzene or thinner. These can cause discoloring and deformation.

Other Precautions

- Keep electrically charged objects away from the input terminals. They may damage the internal circuitry.
- Do not cover the case or operation panel with a volatile material or leave rubber or vinyl products in contact with the case or operation panel for a long time.

Notes on generating accurate source

In a small output range, the error in the source value may become large due to changes in the temperature of the output terminals caused by (1) the conductor making contact when wiring, (2) changes in the temperature inside the instrument due to 4-20mA simulation or loop power, or (3) the movement of the surrounding air. In such situations, wait until the output stabilizes.

In addition, while the instrument is generating output, be careful to keep the output terminal temperature from changing due to the effects air conditioning, other heat sources, and the like.

Storage Precautions

Avoid the following kinds of places for storing the instrument:

- Where the temperature falls outside the storage temperature and humidity ranges
- In direct sunlight or near heat sources
- Where an excessive amount of soot, steam, dust, or corrosive gas is present
- Where the level of mechanical vibration is high
- On an unstable surface
- Where an excessive amount of soot, dust, salt, or iron is present

2.2 Installing the Instrument

WARNING

- Install the instrument so that you can immediately turn off the power if an abnormal or dangerous condition occurs.
- Do not use the instrument to measure locations that fall under Measurement Categories II, III, and IV.

CAUTION

This instrument is equipped with voltage and current source and measurement features. Do not use the instrument when it is wet. Doing so may damage the instrument.

French

AVERTISSEMENT

- Installer l'instrument de manière à pouvoir immédiatement le débrancher du secteur en cas de fonctionnement anormal ou dangereux.
- N'utilisez pas cet équipement pour mesurer des points tombant sous les catégories de mesure II, III et IV.

ATTENTION

- Cet équipement est doté de fonctions de mesure et de source de courant et de tension. N'utilisez pas l'équipement lorsqu'il est mouillé. Le cas échéant, un endommagement de l'équipement risquerait de se produire.

Installation Conditions

Install the instrument in a place that meets the following conditions.

- Operating Altitude and Ambient Temperature and Humidity
- Use the instrument in the following environment.
 - Ambient temperature -10°C to 50°C
 - Ambient humidity 80% RH or less for -10°C to 40°C, 50% RH or less for over 40°C
 - No condensation
- Operating altitude Up to 2000 m

Note

- To ensure high accuracy, operate the instrument within 23°C ± 5°C.
 - When using the instrument in a place where the ambient humidity is 30% or less, take measures to prevent static electricity such as using an anti-static mat.
 - Condensation may occur if the instrument is moved to another place where the ambient temperature or humidity is higher, or if the temperature changes rapidly.
In such cases, allow the instrument adjust to the new environment for at least an hour before using the instrument.
-

Install the instrument in a proper location by referring to “Safety Precautions” on page 8.

Do not install the instrument in the following places, as it can cause incorrect measurements or damage the instrument.

- In direct sunlight or near heat sources
- In an environment with excessive amounts of soot, steam, dust, or corrosive gas
- Near strong magnetic field sources
- Near noise sources, such as high-voltage equipment or power lines
- Where the level of mechanical vibration is high
- On an unstable surface
- Outdoors or in locations subject to rain or water

Measurement Category

The measurement category of this instrument is Other (O).

Measurement Category	Description	Notes
O(None, Other)	Other circuits that are not directly connected to the mains.	Circuits that are not powered from the mains
CAT II	For measurements performed on circuits that are connected to low-voltage installations	Household appliances, portable tools, etc.
CAT III	For measuring facility circuits	Distribution boards, circuit breakers, etc.
CAT IV	For measurements performed on power source circuits	Entrance cables, cable systems, etc.

The estimated transient overvoltage that may appear at the CA500 and CA550 signal input terminals is 500 V.

Fastening the Shoulder Strap

Fasten the shoulder strap to the strap fastening area at the top section on each side of the instrument.

Pass the shoulder strap through the fastening area and then the buckle as shown in the figure. Attach the left and right sides in the same manner.

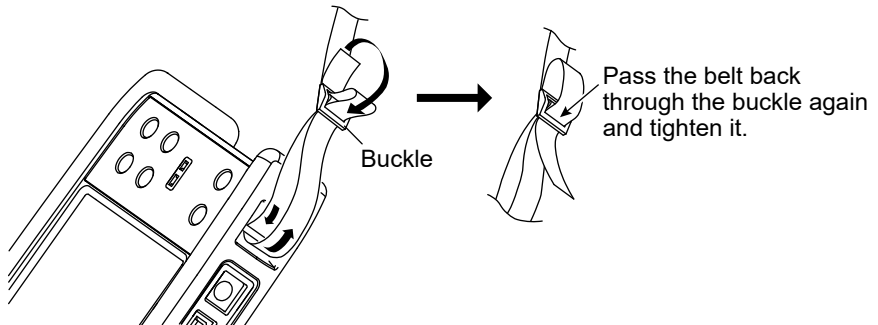

2.3 Connecting Cables



WARNING

Maximum Voltage Application Between Terminals And Earth

The maximum voltage application between measurement terminals and earth is 50 VDC, and that of the source terminals is 30 VDC. To prevent electric shock, do not exceed these voltages.

Source Terminals

To prevent electric shock, observe the following:

- Be careful not apply voltages exceeding the ratings of each terminal.
- Be sure to use the included source lead cables.

Measurement Terminals

- Be careful not apply voltages exceeding the ratings of each terminal.
- Before connecting or disconnecting measurement/source lead cables from the device under measurement, turn off the device under measurement. Connecting or disconnecting measurement/source lead cables with the device under measurement turned on is extremely dangerous.
- If you connect the H voltage input terminal and mA current input terminal incorrectly, the device under measurement or this instrument may break.

Be sure to check that the measurement function setting and the terminal connection are correct.



CAUTION

- Do not apply a voltage to the output terminal for measurements other than temperature measurements using a thermal couple. If you apply a voltage by mistake, the internal circuit may break.
-

French



AVERTISSEMENT

Application de la Tension Maximale Entre les Bornes et la Terre

L'application de la tension maximale entre les bornes et la terre est 50 VDC, et celle des bornes de source est 30 VDC. Pour éviter le choc électrique, ne pas dépasser ces tensions.

Bornes de Source

Pour éviter le choc électrique, observer les points suivants:

- Veiller à ne pas appliquer les tensions dépassant les tensions nominales de chaque borne.
- Veiller à utiliser les câbles de raccordement de la source fournis.

Bornes de Mesure

- Veiller à ne pas appliquer les tensions dépassant les tensions nominales de chaque borne.
 - Avant de brancher ou débrancher des câbles de raccordement de la mesure/source de l'appareil faisant l'objet de la mesure, mettre l'appareil hors tension. Il est extrêmement dangereux de brancher ou débrancher des câbles de raccordement de la mesure/source pendant que l'appareil faisant l'objet de la mesure est en cours.
 - Si vous branchez incorrectement le borne de la tension d'entrée "H" et le borne du courant d'entrée "mA", l'appareil faisant l'objet de la mesure ou cet instrument pourrait casser.
Veiller à vérifier que le réglage de la fonction de mesure et le branchement de la borne sont corrects.
-
-



ATTENTION

- Ne pas appliquer de tension sur la borne de sortie pour les mesures autres que les mesures de la température qui utilisent une sonde thermocouple.
Si vous appliquez la tension par erreur, le circuit d'interne pourrait casser..
-

Note

Pressing INFO displays a wiring diagram of the selected function.

Before Using the Binding Post

Before using the included binding post, remove the short plate attached to the binding post.

Inserting or Removing Lead Cables

Insert or remove lead cables straight from the instrument's terminals.
Do not apply force at an angle.

2 Preparation before Use

DC Voltage Source

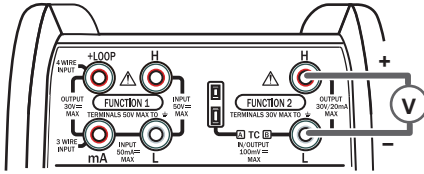

DC current source

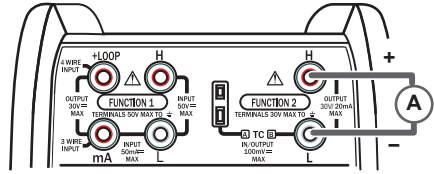

DC Voltage Measurement

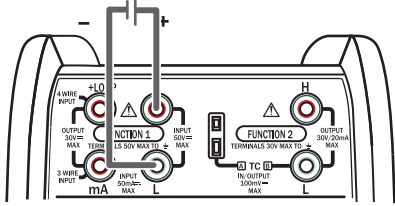

DC Current Measurement

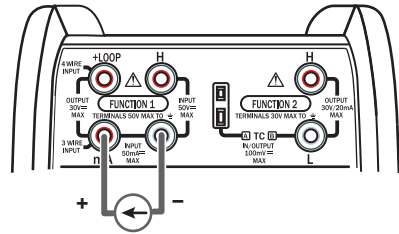

20 mA simulate

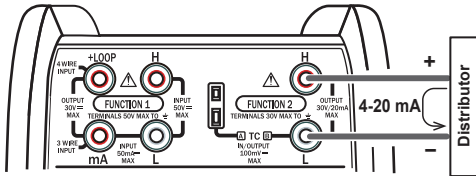

Loop Power

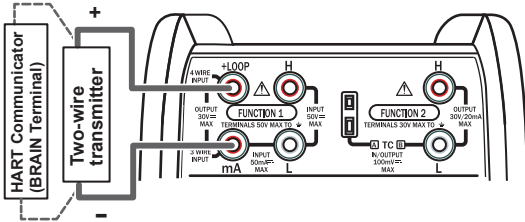

Thermocouple Source

When using the TC-A mini plug terminal

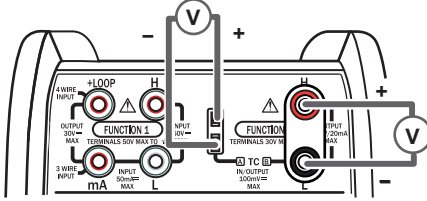

When using the banana plug*

Thermocouple measurement

When using the TC-A mini plug terminal

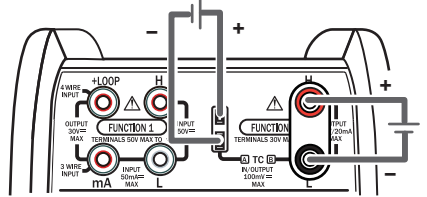

When using the banana plug*

Resistance/RTD Source*

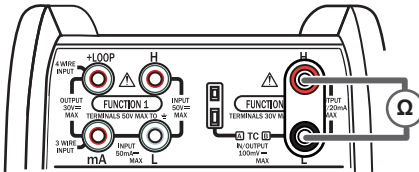

Resistance/RTD Measurement (4W)

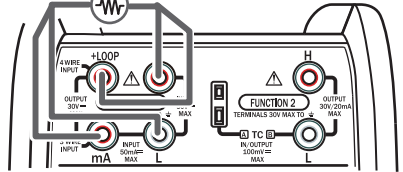

Resistance/RTD Measurement (3W)

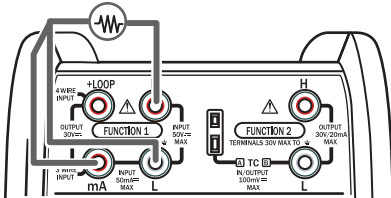

Resistance/RTD Measurement (2W)

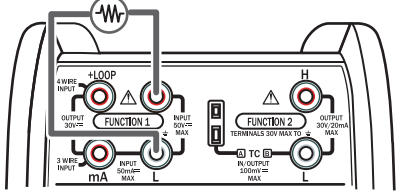

Pulse Source

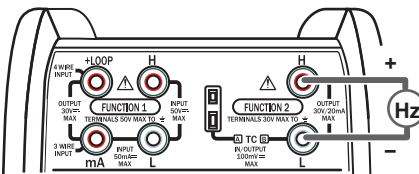

Pulse Measurement (4W)

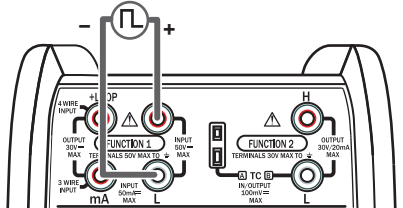

*: Example of using a binding post
Attach according to the terminal color.

Before using the included binding post, remove the short plate attached to the binding post.

HART/BRAIN Communication

Example in which loop power is supplied from the CA550 and the CA550 built-in communication resistor is used

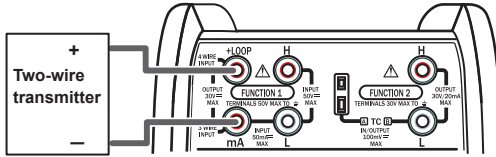

Example in which loop power is supplied from the distributor and an external communication resistor is used

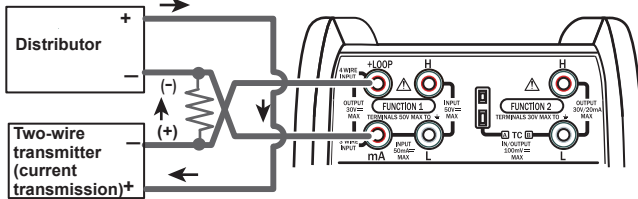

Connect the +LOOP terminal so that its electric potential is higher than that of the current terminal (mA).

CAUTION

When using this instrument as a HART/BRAIN modem, be sure to connect the terminals so that the +LOOP terminal of this instrument is at a higher electric potential than the current terminal. Otherwise, the +LOOP terminal and the current terminal may be shorted by the internal protection circuit and may damage the field instrument.

French

ATTENTION

Lorsque vous utilisez cet instrument comme modem HART / BRAIN, assurez-vous de connecter les bornes de sorte que la borne + LOOP de cet instrument soit à un potentiel électrique plus élevé que la borne de courant. Sinon, la borne + LOOP et la borne de courant peuvent être court-circuitées par le circuit de protection interne et peuvent endommager l'instrument de terrain.

Note

When using the instrument in a location susceptible to noise, take appropriate measures such as shielding according to the transmitter's cable specifications.

Using Thermocouple Mini Plugs

The TC-A terminal is a dedicated thermocouple mini plug terminal.

Using the thermocouple mini plug results in more stable reference junction compensation than using a banana terminal.

Use the same type of thermocouple mini plug as the plug on the item to be calibrated (thermocouple or range of the device to be calibrated).

(Use the thermocouple mini plug set 90040 or 90045 or a thermocouple mini plug that you prepared.)

To connect the plug and the item to be calibrated, use the same type of thermocouple or compensating lead wire as that used on the item to be calibrated. (Prepare your own thermocouple or compensating lead wires.)

2.4 Loading and Removing Batteries



WARNING

- Never replace the batteries with the main unit turned on.
- Insert batteries with the correct polarity as shown inside the battery holder. Otherwise, the batteries may leak, heat up, or burst.
- Do not mix new and old batteries or mix different brands or types of batteries. The batteries may leak, heat up, or burst due to their characteristic differences.
- When replacing batteries, be sure to remove the lead cables.

French



AVERTISSEMENT

- Ne retirez pas les piles lorsque le boîtier principal est en marche.
- Insérer les batteries en observant la polarité correcte. A défaut, les batteries risquent de fuir, de chauffer ou d'éclater.
- Ne pas mélanger des batteries neuves et des batteries usagées, ni des batteries de marques ou de types différents. Les batteries risquent de fuir, de chauffer ou d'éclater en raison de leurs différentes caractéristiques.
- Lors du remplacement des batteries, veillez à retirer les câbles de plomb.

1. Turn the power off.
2. Lift the rear panel stand.
3. Using a coin or the like, turn the battery cover lock key to the left (counterclockwise) by 90°.

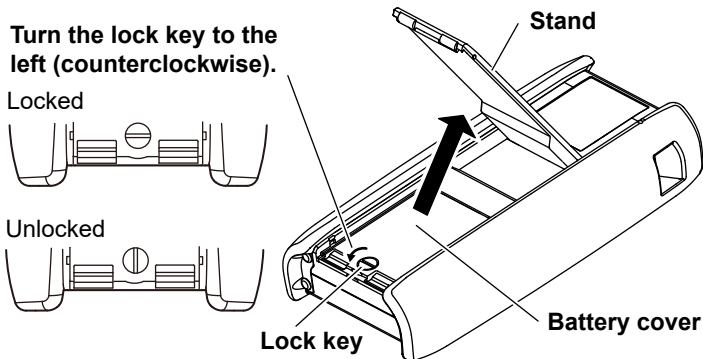

4. Remove the battery cover.

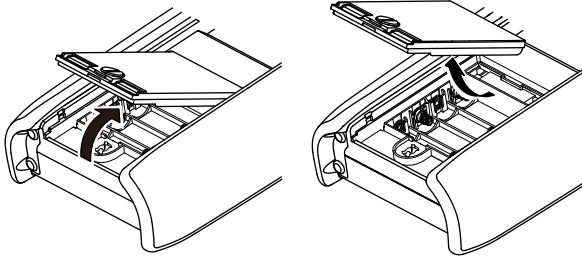

5. Insert new batteries into the battery holder. Insert the batteries in the correct orientation according to the polarity markings in the battery holder.
6. Attach the battery cover. Insert the battery cover tab into the battery holder hole, and close the battery cover.

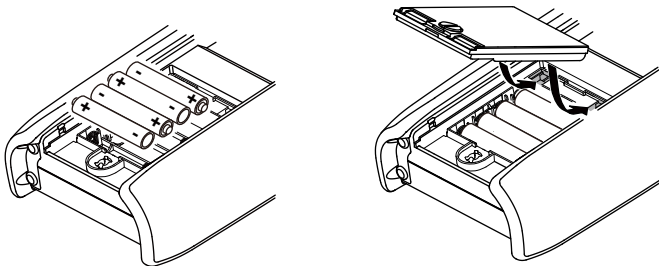

7. Turn the lock key to the right (clockwise) by 90°.

Battery Life

The battery life after replacing with new batteries is about 16 hours (at 5 V range, 10 k Ω load) at an ambient temperature of 23 \pm 5°C. Due to the characteristics of batteries, the battery life is typically reduced as the ambient temperature is decreased.

Battery level

The remaining battery power is displayed with an indicator as shown below.

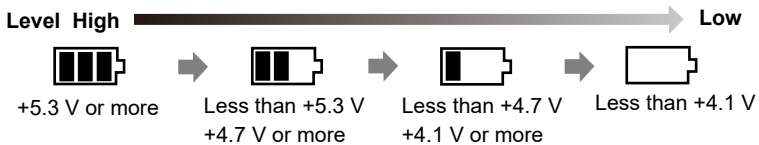

*: The voltage indicates the remaining battery power.

2.5 Supplying Power through the USB Terminal



WARNING

- Use a USB power supply that can supply stable power and that complies with the specifications of this instrument
 - For details on handling the USB power supply, follow the instruction manual of the power supply.
-

French



AVERTISSEMENT

- Utilisez une alimentation USB pouvant fournir une alimentation stable et conforme aux spécifications de cet instrument.
 - Pour les détails de la manipulation de l'adaptateur d'alimentation USB, suivez le manuel d'instruction de l'adaptateur.
-

1. Using the included USB cable, connect the USB power supply to the USB port on the side panel of this instrument.

Note

- If both the batteries and USB power supply are available and the preferred power supply is set to batteries, the battery level is displayed instead of "USB". The batteries argues for the power supply. For instructions on how to change the preferred power supply setting, see the "Other Functions" in the Users Manual (IM CA500-01EN) in the CD.
 - Please use the USB power supply that can supply a current of 500 mA or more.
-

2.6 Turning the Power On and Off

Before Turning On the Power, Check That:

- The instrument is installed properly. See section 2.2, “Installation.”
- The batteries are inserted properly. See section 2.4, “Loading and Removing Batteries.”
- The USB power supply is connected properly. See section 2.5, “Supplying Power through the USB Terminal.”

Turning the Power On

1. Press  (POWER key) on the front panel.

When the self-test is completed, measurement value and output value are displayed.

If an error occurs during a self-test, an error code and “Push Any Key” are displayed. Check the details of the error in “Self-Test Errors” on page 41, and press any key. The measured value and source value are displayed.

If the symptom persists even after you turn the power off and then back on again, contact your nearest YOKOGAWA dealer.

Power-On Operation

When the power is turned on, a self-test starts automatically.

If the instrument does not power on properly, turn the power off, and check that:

- The dry cells are inserted properly.
- The USB power supply is connected properly.
- New and old dry cells are not being used together.
- Batteries of different types or different brands are being used together.
- Check whether the power supply that you are using can supply a current of 500 mA or more.

If the instrument still does not work properly, contact your nearest YOKOGAWA dealer for repairs.

Turning the Power Off



CAUTION

- Do not turn off the instrument when the instrument's output is turned on. Doing so can damage the instrument. It can also cause damage to the devices connected to the instrument. Turn off the output first and then the instrument.

French



ATTENTION

- Ne mettez pas l'instrument hors tension lorsque sa sortie est activée. Cela pourrait endommager l'instrument ou les périphériques connectés à l'instrument. Eteignez d'abord la sortie, puis l'instrument.

1. Press .

2.7 Setting the Date and Time

This section explains how to set the date and time.

For details on the operation, see chapter 3, "Common Operations."

1. Press **MENU**.
2. Press the cursor keys to select **Device Setup**.
3. Press **ENTER**. A Device Setup screen appears.
4. Press the **cursor keys** several times to display Device Setup 2/2.
5. Press the **cursor keys** to select **Date Format**.

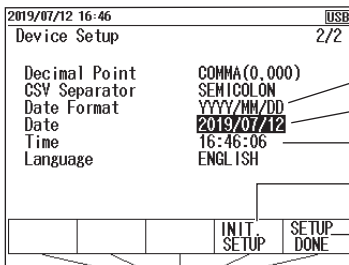

Set the date display format.

Set the date.

Set the time.

Initializes the settings

Confirms the settings and closes the setup screen

6. Press **ENTER**. A setup screen appears for the date display format.
7. Use the **cursor keys** to select the date display format, and then press **ENTER**.

YYYY: year (Gregorian), MM: month, DD: day

8. Use the cursor keys to select **Date**, and then press **ENTER**. The date is displayed at the bottom of the screen.

Date	2019/05/01
Time	18:34:48
Language	English

2019/05/01

9. Using the **arrow keys** corresponding to the digits you want to set, set the year, month, and day.
10. Press **ENTER**. The date is set.
11. Use the cursor keys to select **Time**, and then press **ENTER**. The time is displayed at the bottom of the screen.
12. Using the **arrow keys** for the digits you want to set, set the hour, minute, and second.
13. Press **ENTER**. The time is set.
14. From the selection menu, **SETUP DONE**. The settings are confirmed, and the setup screen closes.

3 Common Operations

3.1 Opening and Closing Setup Screens

To open a setup screen, press the appropriate key on a screen showing the measured value or source value.

After entering the settings, to confirm the settings and close the screen, select SETUP DONE from the selection menu.

When you press the ESC key to close the screen, the changes are not applied.

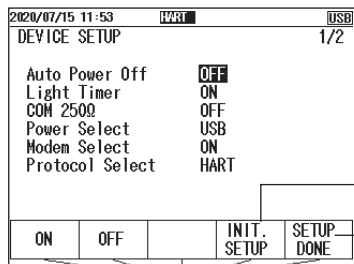

Initializes the settings

Confirms the settings and closes the setup screen

3.2 Setup Screen Operation

On the setup screen, the highlighted item is selected.

To open the next menu, press ENTER.

To change the selected item, press the cursor keys (UP/DOWN key).

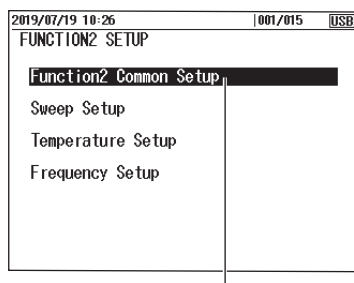

ENTER key

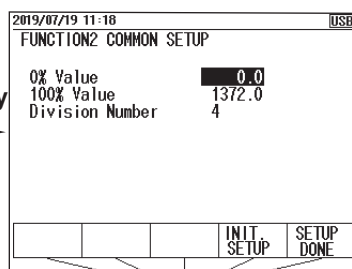

Selected item

Use the cursor keys (UP and DOWN key) to select an item.

The operation varies depending on the item you are setting.

Items selected from a list of options:

When you select an item, the available options are displayed in the selection menu (see section 3.3).

Items that require a value to be set:

Select an item, and then press ENTER. The value appears at the bottom of the screen (see section 3.4).

Items that require alphanumeric characters to be set:

Select an item, and then press ENTER. A window appears for entering alphanumeric characters (see section 3.5).

3.3 Selection Menu Operation

When a selection menu appears at the bottom of the screen, use the arrow keys to make selections.

When the setup menu has one row

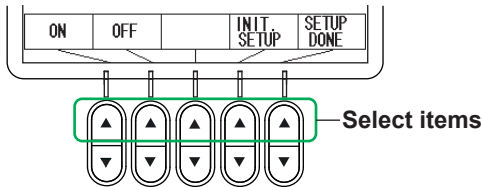

When the setup menu has two rows

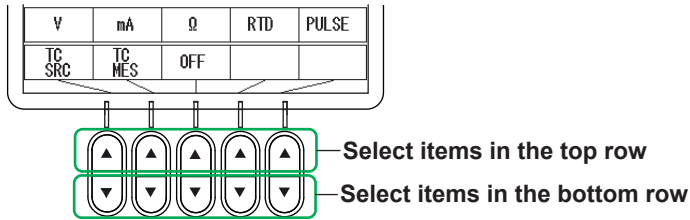

3.4 Specifying Values

Select the item you want to set the value of and press ENTER to display the value at the bottom of the screen. If the source value is displayed, you can change it directly.

Using the arrow keys corresponding to the digits you want to set, set the value.

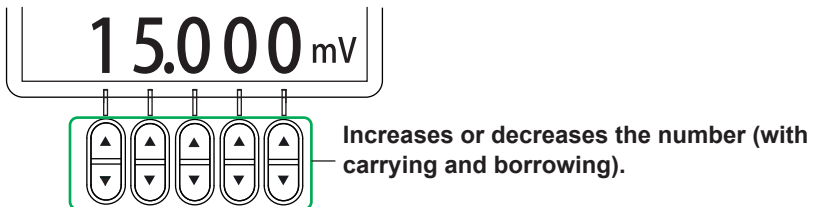

After setting the value using the arrow keys, press ENTER to confirm the value. When setting the source value, you do not need to press ENTER.

3.5 Setting Alphanumeric Characters

Select an item you want to set alphanumeric characters for and press ENTER to display a window for entering alphanumeric characters.

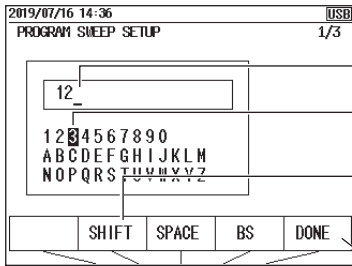

The screenshot shows a menu titled "PROGRAM SWEEP SETUP" with a page indicator "1/3" and a "USB" icon. The menu contains a list of alphanumeric characters: "12", "3", "4", "5", "6", "7", "8", "9", "0", "A", "B", "C", "D", "E", "F", "G", "H", "I", "J", "K", "L", "M", "N", "O", "P", "Q", "R", "S", "T", "U", "V", "W", "X", "Y", "Z". A cursor is positioned over the character "3". Below the list are four buttons: "SHIFT", "SPACE", "BS", and "DONE".

- Character input position
- Use the **cursor keys** to select the character and the **ENTER** key to input the character.
- Switches the selected character to "number + uppercase character" or "symbol + lowercase character"
- Confirms the character string and closes the set up screen

4 Troubleshooting, Maintenance, and Inspection

4.1 Troubleshooting Faults and Corrective Actions

If servicing is necessary, or if the instrument does not operate properly even after you have attempted to deal with the problem according to the instructions in this section, contact your nearest YOKOGAWA dealer.

Problems and Solutions		Reference Page
The instrument does not turn on.	Check the battery level.	32
	Check that the batteries are inserted correctly. Or, check that the USB power supply adapter is connected properly.	31 to 33
The power turns off.	Check the battery level.	32
	Check whether the power supply that you are using can supply a current of 500 mA or more.	33
The screen is dark.	Increase the display light setting.	IM CA500-01EN*
The screen turns off.	Set auto power-off to OFF.	IM CA500-01EN*
The display is odd.	Confirm that the ambient temperature and humidity are within their specified ranges.	24
	Confirm that the display is not being affected by noise.	24
	Restart the instrument.	34
The measured or source value is odd.	Check the battery level.	32
	Check whether the power supply that you are using can supply a current of 500 mA or more.	33
	Check that connections are correct.	26
	Confirm that the ambient temperature and humidity are within their specified ranges.	24
	When using the included binding post for sourcing thermoelectromotive force of a thermocouple, check that the short bar has been removed.	–
A self-test error appears at power-on.	This indicates that the settings have been initialized due to an error in the setting information stored in the instrument. If the error appears every time at power-on, repair is necessary.	–
	There is an error in the calibration data stored in the instrument. If the error appears every time at power-on, repair is necessary.	–

* User's manual in the CD

4.2 Error Codes, Error Messages, and Corrective Actions

Information and Warning Messages

No.	Message	Cause, Corrective Action
01	Storage No Space Error	The internal memory is full and cannot store. Delete unneeded data.
02	Battery is Not Connect.	The power was turned off because the supply voltage dropped low. Replace the battery, or change to a USB power supply that meets the power supply specifications.

Communication Errors

No.	Message	Cause, Corrective Action
11	ERR11	An unused command was received. Check whether the command is correct.
12	ERR12	The command parameter is not specified correctly. Check the parameter.
13	ERR13	A command that cannot be executed in the instrument's current condition was received. Check the device status.

Error Messages (Hardware Errors)

No.	Message	Cause, Corrective Action
23	Over Current (Measure)	The generated output is overcurrent.
24	Over Voltage (Measure)	The generated output is overvoltage.
25	Over Current (Source)	The generated output is overcurrent.

Error Messages (Self-Test Errors)

No.	Message	Cause, Corrective Action
31	Measure adjustment value is broken.	The factory adjustment value is abnormal. The adjustment value was restored.
32	Source adjustment value is broken.	The device settings are abnormal. The settings were initialized.
53	RTC Initialized.	The RTC backup power supply is abnormal. The date and time were initialized.

Self-Test Errors (Critical Self-Test Errors)

No.	Message	Cause, Corrective Action
81	Measure CPU not started.	The measurement CPU is abnormal. Servicing is required.
82	Measure CPU not adjusted.	The measurement CPU has not been adjusted. Servicing is required.
83	Source CPU not started.	The source CPU is abnormal. Servicing is required.
84	Source CPU not adjusted.	The source CPU is not adjusted. Servicing is required.
85	Internal memory access error (1).	No SD card is inserted. Servicing is required.
86	Internal memory access error (2).	The SD card could not be accessed. Servicing is required.
87	Internal memory access error (3).	The internal flash memory cannot be accessed. Servicing is required.
88	RTC Test error.	The RTC is abnormal. Servicing is required.

4.3 Displaying Instrument Information

The instrument information can be displayed.

1. Press INFO.

The screenshot shows the instrument's display interface. At the top, it displays the date and time '2019/07/19 10:59' and the unit identifier '001/015' with a 'USB' icon. Below this is a wiring diagram for a temperature measurement setup. The diagram shows a battery connected to a voltmeter (V) and a temperature sensor (TC) with '+' and '-' terminals. The sensor is connected to terminals labeled 'H', 'L', '+TC', and '-TC'. Below the diagram is a section titled 'DEVICE INFORMATION' with the following details:

Model No.	CA550-F3
Serial No.	HKV51A008
Firmware Version	1.0.0.0
Inspection Date	2019/07/19

Labels on the right side of the screenshot point to the following information:

- Wiring diagram corresponding to the range setting of Function 1 and Function 2
- Model
- Serial number
- Firmware version

Factory Calibration Date (performed at YOKOGAWA)
If user adjustment was made and an adjustment date was set,
the user adjustment date is displayed.

4.4 Recommended Replacement Parts, Consumable Parts, Calibration and Adjustment

Recommended Replacement Parts and Consumable Parts

YOKOGAWA guarantees the instrument for the period and under the conditions of the product warranty.

Calibration

To ensure accuracy, we recommend periodic calibration.

Recommended calibration period: 1 year

Adjustment

Contact your nearest YOKOGAWA dealer to have your instrument adjusted. You can also make adjustments to the instrument. Have a qualified engineer adjust the instrument at a facility with sufficient precision. A manual explaining the adjustment procedure of the instrument is available for downloading from the following webpage. To download the information, you need to register.

<https://tmi.yokogawa.com/solutions/products/portable-and-bench-instruments/calibrators/ca500-series-multi-function-process-calibrator/#Documents-Downloadsa>

5. Specifications

5.1 DC Voltage, DC Current, Resistance and Pulse Source

DC Voltage Source

Range	Resolution	Source Range	Accuracy (1 year) ±(% of setting + offset)		Notes
			CA500	CA550	
100 mV	1 µV	±110.000 mV	0.015% + 10 µV	0.015% + 5 µV	Maximum output current: 10 mA
1-5V	0.1 mV	0.0000 to 6.0000 V	0.015% + 0.5 mV		Maximum output current: 10 mA Value output function supporting square root computation is available.
5 V	0.1 mV	±6.0000 V	0.015% + 0.5 mV		Maximum output current: 10 mA
30 V	1 mV	±33.000 V	0.015% + 5 mV		Maximum output current: 1 mA

Accuracy guaranteed under +23°C±5°C, 20 to 80%RH

Add a temperature coefficient of 0.005% of Range/°C for -10°C to +18°C and +28°C to +50°C.

The source accuracy is defined for the following conditions.

- The specified cable is used to source the signal.
- The effect of the voltage drop in the cable is excluded.
- The effect of the aging of the instrument is excluded.

DC Current Source

Range	Resolution	Source Range	Accuracy (1 year) ±(% of setting + offset)		Notes
			CA500	CA550	
20 mA	1 µA	±24.000 mA	0.015% + 3 µA	0.010% + 2 µA	Source voltage: 0 to +20 V
4-20 mA	1 µA	0.000 to 24.000 mA (4.000 mA steps)	0.015% + 3 µA	0.010% + 2 µA	Source voltage: 0 to +20 V Value output function supporting square root computation is available.
20 mA SIMULATE	1 µA	0.000 to +24.000 mA	0.015% + 3 µA	0.010% + 2 µA	External power supply +5 to +28 V Value output function supporting square root computation is available.

Accuracy guaranteed under +23°C±5°C, 20 to 80%RH

Add a temperature coefficient of 0.005% of Range/°C for -10°C to +18°C and +28°C to +50°C.

5. Specifications

The source accuracy is defined for the following conditions.

- The specified cable is used to source the signal.
- The effect of the voltage drop in the cable is excluded.
- The effect of the aging of the instrument is excluded.

Resistance Source

Range	Resolution	Source Range	Accuracy (1 year) ¹ ±(% of setting + offset)		Notes
			CA500	CA550	
400 Ω	10 mΩ	0.00 to 440.00 Ω	0.020% + 0.1 Ω	0.015% + 0.05 Ω	Allowable measurement current: 0.1 to 3 mA
4000 Ω	100 mΩ	0.0 to 4400.0 Ω	0.020% + 0.5 Ω	0.015% + 0.2 Ω	Allowable measurement current: 0.05 to 0.6 mA

Accuracy guaranteed under +23°C±5°C, 20 to 80%RH

Add a temperature coefficient of 0.005% of Range/°C for -10°C to +18°C and +28°C to +50°C.

The source accuracy is defined for the following conditions.

- The specified cable is used to source the signal.
- The effect of the voltage drop in the cable is excluded.
- The effect of the aging of the instrument is excluded.

1: Accuracy when using the included binding post (99045).

Frequency/Pulse Source

Range	Resolution	Source Range	1-Year Accuracy ±(% of setting + offset)		Notes
			CA500	CA550	
500Hz	0.01 Hz	1.00 to 550.00 Hz	0.005% + 0.01 Hz		Square wave, 50% Duty Cycle, +0.1 to +15 V
5000Hz	0.1 Hz	1.0 to 5500.0 Hz	0.005% + 0.1 Hz		
50kHz	0.001 kHz	0.001 to 50.000 kHz	+0.005% + 0.001 kHz		Pulse count: Continuous, 1 to 999999 cycles Maximum load current: 10 mA Non-voltage contact compatible
CPM	0.1 /min	1.0 to 1100.0 /min	0.5 /min		

Accuracy guaranteed under +23°C±5°C, 20 to 80%RH

Add a temperature coefficient of 0.005% of Range/°C for -10°C to +18°C and +28°C to +50°C.

The source accuracy is defined for the following conditions.

- The specified cable is used to source the signal.
- The effect of the voltage drop in the cable is excluded.
- The effect of the aging of the instrument is excluded.

5.2 DC Voltage, DC Current, Resistance and Pulse Measurement

DC Voltage Measurement

Range	Resolution	Measurement Range	Accuracy (1 year) ±(% of reading + offset)		Notes
			CA500	CA550	
100 mV	1 μV	±110.000 mV	0.015% + 10 μV	0.015% + 5 μV	Input resistance: 1 GΩ or more
5 V	0.1 mV	±6.0000 V	0.015% + 0.5 mV		Input resistance: Approx. 1 MΩ
50 V	1 mV	±55.000 V	0.015% + 5 mV		Input resistance: Approx. 1 MΩ

Accuracy guaranteed under +23°C±5°C, 20 to 80%RH

Add a temperature coefficient of 0.005% of Range/°C for -10°C to +18°C and +28°C to +50°C.

DC Current Measurement

Range	Resolution	Measurement Range	Accuracy (1 year) ±(% of reading + offset)		Notes
			CA500	CA550	
50 mA	1 μA	±60.000 mA	0.015% + 3 μA	0.010% + 2 μA	Input resistance: 10 Ω or less

Accuracy guaranteed under +23°C±5°C, 20 to 80%RH

Add a temperature coefficient of 0.005% of Range/°C for -10°C to +18°C and +28°C to +50°C.

5. Specifications

Resistance Measurement

Range	Resolution	Measurement Range	Accuracy (1 year) ±(% of setting + offset)		Notes
			CA500	CA550	
400 Ω	10 mΩ	0.00 to 440.00 Ω	0.020% + 0.1 Ω	0.015% + 0.05 Ω	Voltage applied current measurement method Typical value: 1 mA(0 Ω) 781 μA(400 Ω) 240 μA(4 kΩ)
4000 Ω	100 mΩ	0.0 to 4400.0 Ω	0.020% + 0.5 Ω	0.015% + 0.2 Ω	

Accuracy guaranteed under +23°C±5°C, 20 to 80%RH

Add a temperature coefficient of 0.005% of Range/°C for -10°C to +18°C and +28°C to +50°C.

Accuracies through four-wire system measurement

For accuracies through three-wire system measurement, add 0.05 Ω for 400 Ω range, 0.2 Ω for 4000 Ω range. However, this assumes that the resistances of all cables are the same.

Assume the accuracies through two-wire system measurement to be the same as those through three-wire system measurement. However, cable resistance are not taken into consideration.

Pulse Measurement

Range	Resolution	Measurement Range	1-Year Accuracy ±(% of setting + offset)		Notes
			CA500	CA550	
500Hz	0.01 Hz	1.00 to 550.00 Hz	0.005% + 0.01 Hz		Measurement time: 1.0 s 0.5 V to 30 Vpp
5000Hz	0.1 Hz	1.0 to 5500.0 Hz	0.005% + 0.1 Hz		
50kHz	0.001 kHz	0.001 to 50.000 kHz	0.005% + 0.001 kHz		Non-voltage contact compatible
PULSE COUNT	1	0 to 99999	2		Maximum integration time: 60 min, 0.5 V to 30 Vpp Non-voltage contact compatible

Accuracy guaranteed under +23°C±5°C, 20 to 80%RH

Add a temperature coefficient of 0.005% of Range/°C for -10°C to +18°C and +28°C to +50°C.

Loop Power Supply

Supply voltage	Notes
24 V ±2 V	Communication resistance: OFF Maximum load current: 24 mA

5.3 Temperature Measurement (TC) and Thermocouple Calibration Voltage Source

When the TC-A terminal (thermocouple plug terminal) and reference junction compensation using the internal temperature sensor are in use

Source Accuracy (common to CA500 and CA550)

Thermocouple	Accuracy (1 year, t: source temperature)		Specification
	Temperature Range	Source Accuracy \pm [°C]	
K	$-200.0^{\circ}\text{C} \leq t < 0.0^{\circ}\text{C}$	$0.5+ t \times 0.30\%$	IEC60584-1 ^{1,2}
	$0.0^{\circ}\text{C} \leq t < +500.0^{\circ}\text{C}$	0.5	
	$+500.0^{\circ}\text{C} \leq t \leq +1372.0^{\circ}\text{C}$	$0.5+(t-500) \times 0.03\%$	
E	$-250.0^{\circ}\text{C} \leq t < -200.0^{\circ}\text{C}$	$1.1+(t -200) \times 2.00\%$	IEC60584-1 ^{1,2}
	$-200.0^{\circ}\text{C} \leq t < 0.0^{\circ}\text{C}$	$0.5+ t \times 0.30\%$	
	$0.0^{\circ}\text{C} \leq t < +500.0^{\circ}\text{C}$	0.5	
	$+500.0^{\circ}\text{C} \leq t \leq +1000.0^{\circ}\text{C}$	$0.5+(t-500) \times 0.02\%$	
J	$-210.0^{\circ}\text{C} \leq t < 0.0^{\circ}\text{C}$	$0.5+ t \times 0.30\%$	IEC60584-1 ^{1,2}
	$0.0^{\circ}\text{C} \leq t \leq +1200.0^{\circ}\text{C}$	$0.5+t \times 0.02\%$	
T	$-250.0^{\circ}\text{C} \leq t < -200.0^{\circ}\text{C}$	$1.1+(t -200) \times 2.50\%$	IEC60584-1 ^{1,2}
	$-200.0^{\circ}\text{C} \leq t < 0.0^{\circ}\text{C}$	$0.5+ t \times 0.30\%$	
	$0.0^{\circ}\text{C} \leq t \leq +400.0^{\circ}\text{C}$	0.5	
N	$-200.0^{\circ}\text{C} \leq t < 0.0^{\circ}\text{C}$	$0.6+ t \times 0.40\%$	IEC60584-1 ¹
	$0.0^{\circ}\text{C} \leq t \leq +1300.0^{\circ}\text{C}$	0.6	
L	$-200.0^{\circ}\text{C} \leq t < 0.0^{\circ}\text{C}$	$0.5+ t \times 0.15\%$	DIN 43710 1985
	$0.0^{\circ}\text{C} \leq t \leq +900.0^{\circ}\text{C}$	0.5	
U	$-200.0^{\circ}\text{C} \leq t < 0.0^{\circ}\text{C}$	$0.5+ t \times 0.20\%$	DIN 43710 1985
	$0.0^{\circ}\text{C} \leq t \leq +600.0^{\circ}\text{C}$	0.5	
R	$-20.0^{\circ}\text{C} \leq t < 0.0^{\circ}\text{C}$	2.0	IEC60584-1 ^{1,2}
	$0.0^{\circ}\text{C} \leq t < +100.0^{\circ}\text{C}$	2.0	
	$+100.0^{\circ}\text{C} \leq t \leq +1767.0^{\circ}\text{C}$	1.4	
S	$-20.0^{\circ}\text{C} \leq t < 0.0^{\circ}\text{C}$	2.0	IEC60584-1 ^{1,2}
	$0.0^{\circ}\text{C} \leq t < +100.0^{\circ}\text{C}$	2.0	
	$+100.0^{\circ}\text{C} \leq t \leq +1768.0^{\circ}\text{C}$	1.4	
B	$+600.0^{\circ}\text{C} \leq t < +800.0^{\circ}\text{C}$	1.2	IEC60584-1 ^{1,2}
	$+800.0^{\circ}\text{C} \leq t < +1000.0^{\circ}\text{C}$	1.0	
	$+1000.0^{\circ}\text{C} \leq t \leq +1820.0^{\circ}\text{C}$	1.0	
C	$0.0^{\circ}\text{C} \leq t < +1000.0^{\circ}\text{C}$	0.8	IEC60584-1 ¹
	$+1000.0^{\circ}\text{C} \leq t \leq +2315.0^{\circ}\text{C}$	$0.8+(t-1000) \times 0.06\%$	
XK	$-200.0^{\circ}\text{C} \leq t < 0.0^{\circ}\text{C}$	$0.4+ t \times 0.20\%$	GOST R 8.585-2001
	$0.0^{\circ}\text{C} \leq t < +300.0^{\circ}\text{C}$	0.4	
	$+300.0^{\circ}\text{C} \leq t \leq +800.0^{\circ}\text{C}$	0.5	
A	$0.0^{\circ}\text{C} \leq t < +1000.0^{\circ}\text{C}$	1.0	IEC60584-1
	$+1000.0^{\circ}\text{C} \leq t \leq +2500.0^{\circ}\text{C}$	$1.0+(t-1000) \times 0.06\%$	

5. Specifications

Thermocouple	Accuracy (1 year, t: source temperature)		Specification
	Temperature Range	Source Accuracy \pm [°C]	
D (W3Re/W25Re)	$0.0^{\circ}\text{C} \leq t < +300.0^{\circ}\text{C}$	1.4	ASTM E1751/ E1751M
	$+300.0^{\circ}\text{C} \leq t < +1500.0^{\circ}\text{C}$	1.2	
	$+1500.0^{\circ}\text{C} \leq t \leq +2315.0^{\circ}\text{C}$	1.8	
G (W/W26Re)	$+100.0^{\circ}\text{C} \leq t < +300.0^{\circ}\text{C}$	1.4	ASTM E1751/ E1751M
	$+300.0^{\circ}\text{C} \leq t < +1500.0^{\circ}\text{C}$	1.2	
	$+1500.0^{\circ}\text{C} \leq t \leq +2315.0^{\circ}\text{C}$	1.8	
PLATINEL II	$0.0^{\circ}\text{C} \leq t < +100.0^{\circ}\text{C}$	0.6	ASTM E1751/ E1751M
	$+100.0^{\circ}\text{C} \leq t < +1000.0^{\circ}\text{C}$	0.8	
	$+1000.0^{\circ}\text{C} \leq t \leq +1395.0^{\circ}\text{C}$	1.0	
PR20-40	$0.0^{\circ}\text{C} \leq t < +500.0^{\circ}\text{C}$	10.0	ASTM E1751
	$+500.0^{\circ}\text{C} \leq t < +1000.0^{\circ}\text{C}$	3.0	
	$+1000.0^{\circ}\text{C} \leq t \leq +1888.0^{\circ}\text{C}$	2.0	

Accuracy guaranteed under $+23^{\circ}\text{C} \pm 5^{\circ}\text{C}$, 20 to 80%RH

Add a temperature coefficient of $0.05^{\circ}\text{C}/^{\circ}\text{C}$ for -10°C to $+18^{\circ}\text{C}$ and $+28^{\circ}\text{C}$ to $+50^{\circ}\text{C}$.

Display resolution of source/measured values: 0.1°C

1 Complies also with JIS C 1602

2 The setting can be changed to comply with IPTS-68 (JIS C 1602 1981).

Measurement Accuracy (common to CA500 and CA550)

Thermocouple	Accuracy (1 year, t: measurement temperature)		Specification
	Temperature Range	Measurement Accuracy \pm [°C]	
K	$-200.0^{\circ}\text{C} \leq t < 0.0^{\circ}\text{C}$	$0.5+ t \times 0.30\%$	IEC60584-1 ^{1, 2}
	$0.0^{\circ}\text{C} \leq t < +500.0^{\circ}\text{C}$	0.5	
	$+500.0^{\circ}\text{C} \leq t \leq +1372.0^{\circ}\text{C}$	$0.5+(t-500) \times 0.02\%$	
E	$-250.0^{\circ}\text{C} \leq t < -200.0^{\circ}\text{C}$	$1.1+(t -200) \times 2.00\%$	IEC60584-1 ^{1, 2}
	$-200.0^{\circ}\text{C} \leq t < 0.0^{\circ}\text{C}$	$0.5+ t \times 0.30\%$	
	$0.0^{\circ}\text{C} \leq t < +500.0^{\circ}\text{C}$	0.5	
	$+500.0^{\circ}\text{C} \leq t \leq +1000.0^{\circ}\text{C}$	$0.5+(t-500) \times 0.02\%$	
J	$-210.0^{\circ}\text{C} \leq t < 0.0^{\circ}\text{C}$	$0.5+ t \times 0.30\%$	IEC60584-1 ^{1, 2}
	$0.0^{\circ}\text{C} \leq t \leq +1200.0^{\circ}\text{C}$	$0.5+ t \times 0.02\%$	
T	$-250.0^{\circ}\text{C} \leq t < -200.0^{\circ}\text{C}$	$1.1+(t -200) \times 2.50\%$	IEC60584-1 ^{1, 2}
	$-200.0^{\circ}\text{C} \leq t < 0.0^{\circ}\text{C}$	$0.5+ t \times 0.30\%$	
	$0.0^{\circ}\text{C} \leq t \leq +400.0^{\circ}\text{C}$	0.5	
N	$-200.0^{\circ}\text{C} \leq t < 0.0^{\circ}\text{C}$	$0.6+ t \times 0.30\%$	IEC60584-1 ¹ ,
	$0.0^{\circ}\text{C} \leq t \leq +1300.0^{\circ}\text{C}$	0.6	
L	$-200.0^{\circ}\text{C} \leq t < 0.0^{\circ}\text{C}$	$0.5+ t \times 0.15\%$	DIN 43710 1985
	$0.0^{\circ}\text{C} \leq t \leq +900.0^{\circ}\text{C}$	0.5	
U	$-200.0^{\circ}\text{C} \leq t < 0.0^{\circ}\text{C}$	$0.5+ t \times 0.20\%$	DIN 43710 1985
	$0.0^{\circ}\text{C} \leq t \leq +600.0^{\circ}\text{C}$	0.5	

Thermocouple	Accuracy (1 year, t: measurement temperature)		Specification
	Temperature Range	Measurement Accuracy \pm [°C]	
R	$-20.0^{\circ}\text{C} \leq t < 0.0^{\circ}\text{C}$	2.0	IEC60584-1 ^{1, 2}
	$0.0^{\circ}\text{C} \leq t < +100.0^{\circ}\text{C}$	1.4	
	$+100.0^{\circ}\text{C} \leq t \leq +1767.0^{\circ}\text{C}$	1.4	
S	$-20.0^{\circ}\text{C} \leq t < 0.0^{\circ}\text{C}$	2.0	IEC60584-1 ^{1, 2}
	$0.0^{\circ}\text{C} \leq t < +100.0^{\circ}\text{C}$	1.4	
	$+100.0^{\circ}\text{C} \leq t \leq +1768.0^{\circ}\text{C}$	1.4	
B	$+600.0^{\circ}\text{C} \leq t < +800.0^{\circ}\text{C}$	1.5	IEC60584-1 ^{1, 2}
	$+800.0^{\circ}\text{C} \leq t < +1000.0^{\circ}\text{C}$	1.2	
	$+1000.0^{\circ}\text{C} \leq t \leq +1820.0^{\circ}\text{C}$	1.1	
C	$0.0^{\circ}\text{C} \leq t < +1000.0^{\circ}\text{C}$	0.8	IEC60584-1 ¹
	$+1000.0^{\circ}\text{C} \leq t \leq +2315.0^{\circ}\text{C}$	$0.8 + (t-1000) \times 0.06\%$	
XK	$-200.0^{\circ}\text{C} \leq t < 0.0^{\circ}\text{C}$	$0.4 + t \times 0.20\%$	GOST R 8.585-2001
	$0.0^{\circ}\text{C} \leq t < +300.0^{\circ}\text{C}$	0.4	
	$+300.0^{\circ}\text{C} \leq t \leq +800.0^{\circ}\text{C}$	0.5	
A	$0.0^{\circ}\text{C} \leq t < +1000.0^{\circ}\text{C}$	1.0	IEC60584-1
	$+1000.0^{\circ}\text{C} \leq t \leq +2500.0^{\circ}\text{C}$	$1.0 + (t-1000) \times 0.06\%$	
D (W3Re/W25Re)	$0.0^{\circ}\text{C} \leq t < +300.0^{\circ}\text{C}$	1.8	ASTM E1751/ E1751M
	$+300.0^{\circ}\text{C} \leq t < +1500.0^{\circ}\text{C}$	1.2	
	$+1500.0^{\circ}\text{C} \leq t \leq +2315.0^{\circ}\text{C}$	2.2	
G (W/W26Re)	$+100.0^{\circ}\text{C} \leq t < +300.0^{\circ}\text{C}$	1.8	ASTM E1751/ E1751M
	$+300.0^{\circ}\text{C} \leq t < +1500.0^{\circ}\text{C}$	1.2	
	$+1500.0^{\circ}\text{C} \leq t \leq +2315.0^{\circ}\text{C}$	2.2	
PLATINEL II	$0.0^{\circ}\text{C} \leq t < +100.0^{\circ}\text{C}$	1.8	ASTM E1751/ E1751M
	$+100.0^{\circ}\text{C} \leq t < +1000.0^{\circ}\text{C}$	1.8	
	$+1000.0^{\circ}\text{C} \leq t \leq +1395.0^{\circ}\text{C}$	2.2	
PR20-40	$0.0^{\circ}\text{C} \leq t < +500.0^{\circ}\text{C}$	11.0	ASTM E1751
	$+500.0^{\circ}\text{C} \leq t < +1000.0^{\circ}\text{C}$	4.0	
	$+1000.0^{\circ}\text{C} \leq t \leq +1888.0^{\circ}\text{C}$	2.0	

Accuracy guaranteed under $+23^{\circ}\text{C} \pm 5^{\circ}\text{C}$, 20 to 80%RH

Add a temperature coefficient of $0.05^{\circ}\text{C}/^{\circ}\text{C}$ for -10°C to $+18^{\circ}\text{C}$ and $+28^{\circ}\text{C}$ to $+50^{\circ}\text{C}$.

Display resolution of source/measured values: 0.1°C

1 Complies also with JIS C 1602

2 The setting can be changed to comply with IPTS-68 (JIS C 1602 1981).

Accuracy with respect to the measurement or source temperature (t) is expressed as constant or a linear equation of t.

Example: Accuracy for Thermocouple K (terminal A) measurement value of $1000.0^{\circ}\text{C} = \pm(0.5 + (1000.0-500) \times 0.02\%)^{\circ}\text{C} = \pm 0.6^{\circ}\text{C}$

5. Specifications

When terminal B (banana terminal) and reference junction compensation using the internal temperature sensor are in use

Source Accuracy (common to CA500 and CA550)

Thermocouple	Accuracy (1 year, t: source temperature)		Specification
	Temperature Range	Source Accuracy ±[°C]	
K	-200.0°C ≤ t < 0.0°C	1.0+ t x 0.75%	IEC60584-1 ^{1, 2}
	0.0°C ≤ t < +500.0°C	1.0	
	+500.0°C ≤ t ≤ +1372.0°C	1.0+(t-500) x 0.04%	
E	-250.0°C ≤ t < -200.0°C	2.0+(t -200) x 7.00%	IEC60584-1 ^{1, 2}
	-200.0°C ≤ t < 0.0°C	1.0+ t x 0.50%	
	0.0°C ≤ t < +500.0°C	1.0	
	+500.0°C ≤ t ≤ +1000.0°C	1.0	
J	-210.0°C ≤ t < 0.0°C	1.0+ t x 0.50%	IEC60584-1 ^{1, 2}
	0.0°C ≤ t ≤ +1200.0°C	1.0+t x 0.02%	
T	-250.0°C ≤ t < -200.0°C	2.5+(t -200) x 7.00%	IEC60584-1 ^{1, 2}
	-200.0°C ≤ t < 0.0°C	1.0+ t x 0.75%	
	0.0°C ≤ t ≤ +400.0°C	1.0	
N	-200.0°C ≤ t < 0.0°C	1.0+ t x 0.75%	IEC60584-1 ¹
	0.0°C ≤ t ≤ +1300.0°C	1.0	
L	-200.0°C ≤ t < 0.0°C	1.0+ t x 0.20%	DIN 43710 1985
	0.0°C ≤ t ≤ +900.0°C	1.0	
U	-200.0°C ≤ t < 0.0°C	1.0+ t x 0.30%	DIN 43710 1985
	0.0°C ≤ t ≤ +600.0°C	1.0	
R	-20.0°C ≤ t < 0.0°C	1.6+ t-100 x 0.50%	IEC60584-1 ^{1, 2}
	0.0°C ≤ t < +100.0°C	1.6+ t-100 x 0.50%	
	+100.0°C ≤ t ≤ +1767.0°C	1.6	
S	-20.0°C ≤ t < 0.0°C	1.6+ t-100 x 0.50%	IEC60584-1 ^{1, 2}
	0.0°C ≤ t < +100.0°C	1.6+ t-100 x 0.50%	
	+100.0°C ≤ t ≤ +1768.0°C	1.6	
B	+600.0°C ≤ t < +800.0°C	1.2	IEC60584-1 ^{1, 2}
	+800.0°C ≤ t < +1000.0°C	1.0	
	+1000.0°C ≤ t ≤ +1820.0°C	1.0	
C	0.0°C ≤ t < +1000.0°C	1.3	IEC60584-1 ¹
	+1000.0°C ≤ t ≤ +2315.0°C	1.3+(t-1000) x 0.08%	
XK	-200.0°C ≤ t < 0.0°C	1.0+ t x 0.50%	GOST R 8.585-2001
	0.0°C ≤ t < +300.0°C	1.0	
	+300.0°C ≤ t ≤ +800.0°C	1.0	
A	0.0°C ≤ t < +1000.0°C	1.5	IEC60584-1
	+1000.0°C ≤ t ≤ +2500.0°C	1.5+(t-1000) x 0.08%	
D (W3Re/W25Re)	0.0°C ≤ t < +300.0°C	1.4	ASTM E1751/ E1751M
	+300.0°C ≤ t < +1500.0°C	1.2	
	+1500.0°C ≤ t ≤ +2315.0°C	1.8	

Thermocouple	Accuracy (1 year, t: source temperature)		Specification
	Temperature Range	Source Accuracy \pm [°C]	
G (W/W26Re)	$+100.0^{\circ}\text{C} \leq t < +300.0^{\circ}\text{C}$	1.4	ASTM E1751/ E1751M
	$+300.0^{\circ}\text{C} \leq t < +1500.0^{\circ}\text{C}$	1.2	
	$+1500.0^{\circ}\text{C} \leq t \leq +2315.0^{\circ}\text{C}$	1.8	
PLATINEL II	$0.0^{\circ}\text{C} \leq t < +100.0^{\circ}\text{C}$	1.0	ASTM E1751/ E1751M
	$+100.0^{\circ}\text{C} \leq t < +1000.0^{\circ}\text{C}$	1.0	
	$+1000.0^{\circ}\text{C} \leq t \leq +1395.0^{\circ}\text{C}$	1.2	
PR20-40	$0.0^{\circ}\text{C} \leq t < +500.0^{\circ}\text{C}$	10.0	ASTM E1751
	$+500.0^{\circ}\text{C} \leq t < +1000.0^{\circ}\text{C}$	3.0	
	$+1000.0^{\circ}\text{C} \leq t \leq +1888.0^{\circ}\text{C}$	2.0	

Accuracy guaranteed under $+23^{\circ}\text{C} \pm 5^{\circ}\text{C}$, 20 to 80%RH

Add a temperature coefficient of $0.05^{\circ}\text{C}/^{\circ}\text{C}$ for -10°C to $+18^{\circ}\text{C}$ and $+28^{\circ}\text{C}$ to $+50^{\circ}\text{C}$.

Display resolution of source/measured values: 0.1°C

Accuracy when using the included binding post (99045).

1 Complies also with JIS C 1602

2 The setting can be changed to comply with IPTS-68 (JIS C 1602 1981).

Measurement Accuracy (common to CA500 and CA550)

Thermocouple	Accuracy (1 year, t: measurement temperature)		Specification
	Temperature Range	Measurement Accuracy \pm [°C]	
K	$-200.0^{\circ}\text{C} \leq t < 0.0^{\circ}\text{C}$	$1.0 + t \times 0.75\%$	IEC60584-1 ^{1, 2}
	$0.0^{\circ}\text{C} \leq t < +500.0^{\circ}\text{C}$	1.0	
	$+500.0^{\circ}\text{C} \leq t \leq +1372.0^{\circ}\text{C}$	$1.0 + (t - 500) \times 0.04\%$	
E	$-250.0^{\circ}\text{C} \leq t < -200.0^{\circ}\text{C}$	$2.0 + (t - 200) \times 7.00\%$	IEC60584-1 ^{1, 2}
	$-200.0^{\circ}\text{C} \leq t < 0.0^{\circ}\text{C}$	$1.0 + t \times 0.50\%$	
	$0.0^{\circ}\text{C} \leq t < +500.0^{\circ}\text{C}$	1.0	
	$+500.0^{\circ}\text{C} \leq t \leq +1000.0^{\circ}\text{C}$	1.0	
J	$-210.0^{\circ}\text{C} \leq t < 0.0^{\circ}\text{C}$	$1.0 + t \times 0.50\%$	IEC60584-1 ^{1, 2}
	$0.0^{\circ}\text{C} \leq t \leq +1200.0^{\circ}\text{C}$	$1.0 + t \times 0.02\%$	
T	$-250.0^{\circ}\text{C} \leq t < -200.0^{\circ}\text{C}$	$2.5 + (t - 200) \times 7.00\%$	IEC60584-1 ^{1, 2}
	$-200.0^{\circ}\text{C} \leq t < 0.0^{\circ}\text{C}$	$1.0 + t \times 0.75\%$	
	$0.0^{\circ}\text{C} \leq t \leq +400.0^{\circ}\text{C}$	1.0	
N	$-200.0^{\circ}\text{C} \leq t < 0.0^{\circ}\text{C}$	$1.0 + t \times 0.75\%$	IEC60584-1 ¹
	$0.0^{\circ}\text{C} \leq t \leq +1300.0^{\circ}\text{C}$	1.0	
L	$-200.0^{\circ}\text{C} \leq t < 0.0^{\circ}\text{C}$	$1.0 + t \times 0.20\%$	DIN 43710 1985
	$0.0^{\circ}\text{C} \leq t \leq +900.0^{\circ}\text{C}$	1.0	
U	$-200.0^{\circ}\text{C} \leq t < 0.0^{\circ}\text{C}$	$1.0 + t \times 0.30\%$	DIN 43710 1985
	$0.0^{\circ}\text{C} \leq t \leq +600.0^{\circ}\text{C}$	1.0	
R	$-20.0^{\circ}\text{C} \leq t < 0.0^{\circ}\text{C}$	$1.6 + t - 100 \times 0.50\%$	IEC60584-1 ^{1, 2}
	$0.0^{\circ}\text{C} \leq t < +100.0^{\circ}\text{C}$	$1.6 + t - 100 \times 0.50\%$	
	$+100.0^{\circ}\text{C} \leq t \leq +1767.0^{\circ}\text{C}$	1.6	

5. Specifications

Thermocouple	Accuracy (1 year, t: measurement temperature)		Specification
	Temperature Range	Measurement Accuracy \pm [°C]	
S	$-20.0^{\circ}\text{C} \leq t < 0.0^{\circ}\text{C}$	$1.6+ t-100 \times 0.50\%$	IEC60584-1 ^{1,2}
	$0.0^{\circ}\text{C} \leq t < +100.0^{\circ}\text{C}$	$1.6+ t-100 \times 0.50\%$	
	$+100.0^{\circ}\text{C} \leq t \leq +1768.0^{\circ}\text{C}$	1.6	
B	$+600.0^{\circ}\text{C} \leq t < +800.0^{\circ}\text{C}$	1.5	IEC60584-1 ^{1,2}
	$+800.0^{\circ}\text{C} \leq t < +1000.0^{\circ}\text{C}$	1.2	
	$+1000.0^{\circ}\text{C} \leq t \leq +1820.0^{\circ}\text{C}$	1.1	
C	$0.0^{\circ}\text{C} \leq t < +1000.0^{\circ}\text{C}$	1.3	IEC60584-1 ¹
	$+1000.0^{\circ}\text{C} \leq t \leq +2315.0^{\circ}\text{C}$	$1.3+(t-1000) \times 0.08\%$	
XK	$-200.0^{\circ}\text{C} \leq t < 0.0^{\circ}\text{C}$	$1.0+ t \times 0.50\%$	GOST R 8.585-2001
	$0.0^{\circ}\text{C} \leq t < +300.0^{\circ}\text{C}$	1.0	
	$+300.0^{\circ}\text{C} \leq t \leq +800.0^{\circ}\text{C}$	1.0	
A	$0.0^{\circ}\text{C} \leq t < +1000.0^{\circ}\text{C}$	1.5	IEC60584-1
	$+1000.0^{\circ}\text{C} \leq t \leq +2500.0^{\circ}\text{C}$	$1.5+(t-1000) \times 0.08\%$	
D (W3Re/W25Re)	$0.0^{\circ}\text{C} \leq t < +300.0^{\circ}\text{C}$	1.8	ASTM E1751/ E1751M
	$+300.0^{\circ}\text{C} \leq t < +1500.0^{\circ}\text{C}$	1.2	
	$+1500.0^{\circ}\text{C} \leq t \leq +2315.0^{\circ}\text{C}$	2.2	
G (W/W26Re)	$+100.0^{\circ}\text{C} \leq t < +300.0^{\circ}\text{C}$	1.8	ASTM E1751/ E1751M
	$+300.0^{\circ}\text{C} \leq t < +1500.0^{\circ}\text{C}$	1.2	
	$+1500.0^{\circ}\text{C} \leq t \leq +2315.0^{\circ}\text{C}$	2.2	
PLATINEL II	$0.0^{\circ}\text{C} \leq t < +100.0^{\circ}\text{C}$	1.8	ASTM E1751/ E1751M
	$+100.0^{\circ}\text{C} \leq t < +1000.0^{\circ}\text{C}$	1.8	
	$+1000.0^{\circ}\text{C} \leq t \leq +1395.0^{\circ}\text{C}$	2.2	
PR20-40	$0.0^{\circ}\text{C} \leq t < +500.0^{\circ}\text{C}$	11.0	ASTM E1751
	$+500.0^{\circ}\text{C} \leq t < +1000.0^{\circ}\text{C}$	4.0	
	$+1000.0^{\circ}\text{C} \leq t \leq +1888.0^{\circ}\text{C}$	2.0	

Accuracy guaranteed under $+23^{\circ}\text{C} \pm 5^{\circ}\text{C}$, 20 to 80%RH

Add a temperature coefficient of $0.05^{\circ}\text{C}/^{\circ}\text{C}$ for -10°C to $+18^{\circ}\text{C}$ and $+28^{\circ}\text{C}$ to $+50^{\circ}\text{C}$.

Display resolution of source/measured values: 0.1°C

Accuracy when using the included binding post (99045).

1 Complies also with JIS C 1602

2 The setting can be changed to comply with IPTS-68 (JIS C 1602 1981).

When terminal B (banana terminal) and reference junction compensation using the external RJ sensor (sold separately) are in use

Source Accuracy (common to CA500 and CA550)

Thermocouple	Accuracy (1 year, t: source temperature)		Specification
	Temperature Range	Source Accuracy \pm [°C]	
K	$-200.0^{\circ}\text{C} \leq t < 0.0^{\circ}\text{C}$	$0.7 + t \times 0.40\%$	IEC60584-1 ^{1,2}
	$0.0^{\circ}\text{C} \leq t < +500.0^{\circ}\text{C}$	0.7	
	$+500.0^{\circ}\text{C} \leq t \leq +1372.0^{\circ}\text{C}$	$0.7 + (t-500) \times 0.03\%$	
E	$-250.0^{\circ}\text{C} \leq t < -200.0^{\circ}\text{C}$	$1.3 + (t -200) \times 5.00\%$	IEC60584-1 ^{1,2}
	$-200.0^{\circ}\text{C} \leq t < 0.0^{\circ}\text{C}$	$0.7 + t \times 0.30\%$	
	$0.0^{\circ}\text{C} \leq t < +500.0^{\circ}\text{C}$	0.7	
	$+500.0^{\circ}\text{C} \leq t \leq +1000.0^{\circ}\text{C}$	$0.7 + (t-500) \times 0.02\%$	
J	$-210.0^{\circ}\text{C} \leq t < 0.0^{\circ}\text{C}$	$0.7 + t \times 0.30\%$	IEC60584-1 ^{1,2}
	$0.0^{\circ}\text{C} \leq t \leq +1200.0^{\circ}\text{C}$	$0.7 + t \times 0.02\%$	
T	$-250.0^{\circ}\text{C} \leq t < -200.0^{\circ}\text{C}$	$1.7 + (t -200) \times 5.00\%$	IEC60584-1 ^{1,2}
	$-200.0^{\circ}\text{C} \leq t < 0.0^{\circ}\text{C}$	$0.7 + t \times 0.50\%$	
	$0.0^{\circ}\text{C} \leq t \leq +400.0^{\circ}\text{C}$	0.7	
N	$-200.0^{\circ}\text{C} \leq t < 0.0^{\circ}\text{C}$	$0.8 + t \times 0.50\%$	IEC60584-1 ¹
	$0.0^{\circ}\text{C} \leq t \leq +1300.0^{\circ}\text{C}$	0.8	
L	$-200.0^{\circ}\text{C} \leq t < 0.0^{\circ}\text{C}$	$0.7 + t \times 0.15\%$	DIN 43710 1985
	$0.0^{\circ}\text{C} \leq t \leq +900.0^{\circ}\text{C}$	0.7	
U	$-200.0^{\circ}\text{C} \leq t < 0.0^{\circ}\text{C}$	$0.7 + t \times 0.30\%$	DIN 43710 1985
	$0.0^{\circ}\text{C} \leq t \leq +600.0^{\circ}\text{C}$	0.7	
R	$-20.0^{\circ}\text{C} \leq t < 0.0^{\circ}\text{C}$	$1.4 + t-100 \times 0.50\%$	IEC60584-1 ^{1,2}
	$0.0^{\circ}\text{C} \leq t < +100.0^{\circ}\text{C}$	$1.4 + t-100 \times 0.50\%$	
	$+100.0^{\circ}\text{C} \leq t \leq +1767.0^{\circ}\text{C}$	1.4	
S	$-20.0^{\circ}\text{C} \leq t < 0.0^{\circ}\text{C}$	$1.4 + t-100 \times 0.50\%$	IEC60584-1 ^{1,2}
	$0.0^{\circ}\text{C} \leq t < +100.0^{\circ}\text{C}$	$1.4 + t-100 \times 0.50\%$	
	$+100.0^{\circ}\text{C} \leq t \leq +1768.0^{\circ}\text{C}$	1.4	
B	$+600.0^{\circ}\text{C} \leq t < +800.0^{\circ}\text{C}$	1.2	IEC60584-1 ^{1,2}
	$+800.0^{\circ}\text{C} \leq t < +1000.0^{\circ}\text{C}$	1.0	
	$+1000.0^{\circ}\text{C} \leq t \leq +1820.0^{\circ}\text{C}$	1.0	
C	$0.0^{\circ}\text{C} \leq t < +1000.0^{\circ}\text{C}$	1.0	IEC60584-1 ¹
	$+1000.0^{\circ}\text{C} \leq t \leq +2315.0^{\circ}\text{C}$	$1.0 + (t-1000) \times 0.08\%$	
XK	$-200.0^{\circ}\text{C} \leq t < 0.0^{\circ}\text{C}$	$0.6 + t \times 0.30\%$	GOST R 8.585-2001
	$0.0^{\circ}\text{C} \leq t < +300.0^{\circ}\text{C}$	0.6	
	$+300.0^{\circ}\text{C} \leq t \leq +800.0^{\circ}\text{C}$	0.7	
A	$0.0^{\circ}\text{C} \leq t < +1000.0^{\circ}\text{C}$	1.2	IEC60584-1
	$+1000.0^{\circ}\text{C} \leq t \leq +2500.0^{\circ}\text{C}$	$1.2 + (t-1000) \times 0.06\%$	
D (W3Re/W25Re)	$0.0^{\circ}\text{C} \leq t < +300.0^{\circ}\text{C}$	1.4	ASTM E1751/ E1751M
	$+300.0^{\circ}\text{C} \leq t < +1500.0^{\circ}\text{C}$	1.2	
	$+1500.0^{\circ}\text{C} \leq t \leq +2315.0^{\circ}\text{C}$	1.8	

5. Specifications

Thermocouple	Accuracy (1 year, t: source temperature)		Specification
	Temperature Range	Source Accuracy \pm [°C]	
G (W/W26Re)	$+100.0^{\circ}\text{C} \leq t < +300.0^{\circ}\text{C}$	1.4	ASTM E1751/ E1751M
	$+300.0^{\circ}\text{C} \leq t < +1500.0^{\circ}\text{C}$	1.2	
	$+1500.0^{\circ}\text{C} \leq t \leq +2315.0^{\circ}\text{C}$	1.8	
PLATINEL II	$0.0^{\circ}\text{C} \leq t < +100.0^{\circ}\text{C}$	0.6	ASTM E1751/ E1751M
	$+100.0^{\circ}\text{C} \leq t < +1000.0^{\circ}\text{C}$	0.8	
	$+1000.0^{\circ}\text{C} \leq t \leq +1395.0^{\circ}\text{C}$	1.0	
PR20-40	$0.0^{\circ}\text{C} \leq t < +500.0^{\circ}\text{C}$	10.0	ASTM E1751
	$+500.0^{\circ}\text{C} \leq t < +1000.0^{\circ}\text{C}$	3.0	
	$+1000.0^{\circ}\text{C} \leq t \leq +1888.0^{\circ}\text{C}$	2.0	

Accuracy guaranteed under $+23^{\circ}\text{C} \pm 5^{\circ}\text{C}$, 20 to 80%RH

Add a temperature coefficient of $0.05^{\circ}\text{C}/^{\circ}\text{C}$ for -10°C to $+18^{\circ}\text{C}$ and $+28^{\circ}\text{C}$ to $+50^{\circ}\text{C}$.

Display resolution of source/measured values: 0.1°C

Accuracy when using the included binding post (99045).

1 Complies also with JIS C 1602

2 The setting can be changed to comply with IPTS-68 (JIS C 1602 1981).

Measurement Accuracy (common to CA500 and CA550)

Thermocouple	Accuracy (1 year, t: measurement temperature)		Specification
	Temperature Range	Measurement Accuracy \pm [°C]	
K	$-200.0^{\circ}\text{C} \leq t < 0.0^{\circ}\text{C}$	$0.7 + t \times 0.40\%$	IEC60584-1 ^{1,2}
	$0.0^{\circ}\text{C} \leq t < +500.0^{\circ}\text{C}$	0.7	
	$+500.0^{\circ}\text{C} \leq t \leq +1372.0^{\circ}\text{C}$	$0.7 + (t - 500) \times 0.03\%$	
E	$-250.0^{\circ}\text{C} \leq t < -200.0^{\circ}\text{C}$	$1.3 + (t - 200) \times 5.00\%$	IEC60584-1 ^{1,2}
	$-200.0^{\circ}\text{C} \leq t < 0.0^{\circ}\text{C}$	$0.7 + t \times 0.30\%$	
	$0.0^{\circ}\text{C} \leq t < +500.0^{\circ}\text{C}$	0.7	
	$+500.0^{\circ}\text{C} \leq t \leq +1000.0^{\circ}\text{C}$	$0.7 + (t - 500) \times 0.02\%$	
J	$-210.0^{\circ}\text{C} \leq t < 0.0^{\circ}\text{C}$	$0.7 + t \times 0.30\%$	IEC60584-1 ^{1,2}
	$0.0^{\circ}\text{C} \leq t \leq +1200.0^{\circ}\text{C}$	$0.7 + t \times 0.02\%$	
T	$-250.0^{\circ}\text{C} \leq t < -200.0^{\circ}\text{C}$	$1.7 + (t - 200) \times 5.00\%$	IEC60584-1 ^{1,2}
	$-200.0^{\circ}\text{C} \leq t < 0.0^{\circ}\text{C}$	$0.7 + t \times 0.50\%$	
	$0.0^{\circ}\text{C} \leq t \leq +400.0^{\circ}\text{C}$	0.7	
N	$-200.0^{\circ}\text{C} \leq t < 0.0^{\circ}\text{C}$	$0.8 + t \times 0.50\%$	IEC60584-1 ¹
	$0.0^{\circ}\text{C} \leq t \leq +1300.0^{\circ}\text{C}$	0.8	
L	$-200.0^{\circ}\text{C} \leq t < 0.0^{\circ}\text{C}$	$0.7 + t \times 0.15\%$	DIN 43710 1985
	$0.0^{\circ}\text{C} \leq t \leq +900.0^{\circ}\text{C}$	0.7	
U	$-200.0^{\circ}\text{C} \leq t < 0.0^{\circ}\text{C}$	$0.7 + t \times 0.30\%$	DIN 43710 1985
	$0.0^{\circ}\text{C} \leq t \leq +600.0^{\circ}\text{C}$	0.7	
R	$-20.0^{\circ}\text{C} \leq t < 0.0^{\circ}\text{C}$	$1.4 + t - 100 \times 0.50\%$	IEC60584-1 ^{1,2}
	$0.0^{\circ}\text{C} \leq t < +100.0^{\circ}\text{C}$	$1.4 + t - 100 \times 0.50\%$	
	$+100.0^{\circ}\text{C} \leq t \leq +1767.0^{\circ}\text{C}$	1.4	

Thermocouple	Accuracy (1 year, t: measurement temperature)		Specification
	Temperature Range	Measurement Accuracy \pm [°C]	
S	$-20.0^{\circ}\text{C} \leq t < 0.0^{\circ}\text{C}$	$1.4 + t - 100 \times 0.50\%$	IEC60584-1 ^{1, 2}
	$0.0^{\circ}\text{C} \leq t < +100.0^{\circ}\text{C}$	$1.4 + t - 100 \times 0.50\%$	
	$+100.0^{\circ}\text{C} \leq t \leq +1768.0^{\circ}\text{C}$	1.4	
B	$+600.0^{\circ}\text{C} \leq t < +800.0^{\circ}\text{C}$	1.5	IEC60584-1 ^{1, 2}
	$+800.0^{\circ}\text{C} \leq t < +1000.0^{\circ}\text{C}$	1.2	
	$+1000.0^{\circ}\text{C} \leq t \leq +1820.0^{\circ}\text{C}$	1.1	
C	$0.0^{\circ}\text{C} \leq t < +1000.0^{\circ}\text{C}$	1.0	IEC60584-1 ¹
	$+1000.0^{\circ}\text{C} \leq t \leq +2315.0^{\circ}\text{C}$	$1.0 + (t - 1000) \times 0.08\%$	
XK	$-200.0^{\circ}\text{C} \leq t < 0.0^{\circ}\text{C}$	$0.6 + t \times 0.30\%$	GOST R 8.585-2001
	$0.0^{\circ}\text{C} \leq t < +300.0^{\circ}\text{C}$	0.6	
	$+300.0^{\circ}\text{C} \leq t \leq +800.0^{\circ}\text{C}$	0.7	
A	$0.0^{\circ}\text{C} \leq t < +1000.0^{\circ}\text{C}$	1.2	IEC60584-1
	$+1000.0^{\circ}\text{C} \leq t \leq +2500.0^{\circ}\text{C}$	$1.2 + (t - 1000) \times 0.06\%$	
D (W3Re/W25Re)	$0.0^{\circ}\text{C} \leq t < +300.0^{\circ}\text{C}$	1.8	ASTM E1751/ E1751M
	$+300.0^{\circ}\text{C} \leq t < +1500.0^{\circ}\text{C}$	1.2	
	$+1500.0^{\circ}\text{C} \leq t \leq +2315.0^{\circ}\text{C}$	2.2	
G (W/W26Re)	$+100.0^{\circ}\text{C} \leq t < +300.0^{\circ}\text{C}$	1.8	ASTM E1751/ E1751M
	$+300.0^{\circ}\text{C} \leq t < +1500.0^{\circ}\text{C}$	1.2	
	$+1500.0^{\circ}\text{C} \leq t \leq +2315.0^{\circ}\text{C}$	2.2	
PLATINEL II	$0.0^{\circ}\text{C} \leq t < +100.0^{\circ}\text{C}$	1.8	ASTM E1751/ E1751M
	$+100.0^{\circ}\text{C} \leq t < +1000.0^{\circ}\text{C}$	1.8	
	$+1000.0^{\circ}\text{C} \leq t \leq +1395.0^{\circ}\text{C}$	2.2	
PR20-40	$0.0^{\circ}\text{C} \leq t < +500.0^{\circ}\text{C}$	11.0	ASTM E1751
	$+500.0^{\circ}\text{C} \leq t < +1000.0^{\circ}\text{C}$	4.0	
	$+1000.0^{\circ}\text{C} \leq t \leq +1888.0^{\circ}\text{C}$	2.0	

Accuracy guaranteed under $+23^{\circ}\text{C} \pm 5^{\circ}\text{C}$, 20 to 80%RH

Add a temperature coefficient of $0.05^{\circ}\text{C}/^{\circ}\text{C}$ for -10°C to $+18^{\circ}\text{C}$ and $+28^{\circ}\text{C}$ to $+50^{\circ}\text{C}$.

Display resolution of source/measured values: 0.1°C

Accuracy when using the included binding post (99045).

1 Complies also with JIS C 1602

2 The setting can be changed to comply with IPTS-68 (JIS C 1602 1981).

5. Specifications

When terminal B (banana terminal) is in use and reference junction compensation is off

Source Accuracy (common to CA500 and CA550)

Thermocouple	Accuracy (1 year, t: source temperature)		Specification
	Temperature Range	Source Accuracy \pm [°C]	
K	$-200.0^{\circ}\text{C} \leq t < 0.0^{\circ}\text{C}$	$0.3+ t \times 0.20\%$	IEC60584-1 ^{1,2}
	$0.0^{\circ}\text{C} \leq t < +500.0^{\circ}\text{C}$	0.3	
	$+500.0^{\circ}\text{C} \leq t \leq +1372.0^{\circ}\text{C}$	$0.3+(t-500) \times 0.02\%$	
E	$-250.0^{\circ}\text{C} \leq t < -200.0^{\circ}\text{C}$	$0.3+ t \times 0.30\%$	IEC60584-1 ^{1,2}
	$-200.0^{\circ}\text{C} \leq t < 0.0^{\circ}\text{C}$	$0.3+ t \times 0.30\%$	
	$0.0^{\circ}\text{C} \leq t < +500.0^{\circ}\text{C}$	0.3	
	$+500.0^{\circ}\text{C} \leq t \leq +1000.0^{\circ}\text{C}$	$0.3+(t-500) \times 0.02\%$	
J	$-210.0^{\circ}\text{C} \leq t < 0.0^{\circ}\text{C}$	$0.3+ t \times 0.20\%$	IEC60584-1 ^{1,2}
	$0.0^{\circ}\text{C} \leq t \leq +1200.0^{\circ}\text{C}$	$0.3+t \times 0.02\%$	
T	$-250.0^{\circ}\text{C} \leq t < -200.0^{\circ}\text{C}$	$0.7+(t -200) \times 1.00\%$	IEC60584-1 ^{1,2}
	$-200.0^{\circ}\text{C} \leq t < 0.0^{\circ}\text{C}$	$0.3+ t \times 0.20\%$	
	$0.0^{\circ}\text{C} \leq t \leq +400.0^{\circ}\text{C}$	0.3	
N	$-200.0^{\circ}\text{C} \leq t < 0.0^{\circ}\text{C}$	$0.5+ t \times 0.20\%$	IEC60584-1 ¹
	$0.0^{\circ}\text{C} \leq t \leq +1300.0^{\circ}\text{C}$	0.5	
L	$-200.0^{\circ}\text{C} \leq t < 0.0^{\circ}\text{C}$	$0.3+ t \times 0.10\%$	DIN 43710 1985
	$0.0^{\circ}\text{C} \leq t \leq +900.0^{\circ}\text{C}$	0.3	
U	$-200.0^{\circ}\text{C} \leq t < 0.0^{\circ}\text{C}$	$0.3+ t \times 0.10\%$	DIN 43710 1985
	$0.0^{\circ}\text{C} \leq t \leq +600.0^{\circ}\text{C}$	0.3	
R	$-20.0^{\circ}\text{C} \leq t < 0.0^{\circ}\text{C}$	1.8	IEC60584-1 ^{1,2}
	$0.0^{\circ}\text{C} \leq t < +100.0^{\circ}\text{C}$	1.2	
	$+100.0^{\circ}\text{C} \leq t \leq +1767.0^{\circ}\text{C}$	1.2	
S	$-20.0^{\circ}\text{C} \leq t < 0.0^{\circ}\text{C}$	1.8	IEC60584-1 ^{1,2}
	$0.0^{\circ}\text{C} \leq t < +100.0^{\circ}\text{C}$	1.2	
	$+100.0^{\circ}\text{C} \leq t \leq +1768.0^{\circ}\text{C}$	1.2	
B	$+600.0^{\circ}\text{C} \leq t < +800.0^{\circ}\text{C}$	1.1	IEC60584-1 ^{1,2}
	$+800.0^{\circ}\text{C} \leq t < +1000.0^{\circ}\text{C}$	0.9	
	$+1000.0^{\circ}\text{C} \leq t \leq +1820.0^{\circ}\text{C}$	0.9	
C	$0.0^{\circ}\text{C} \leq t < +1000.0^{\circ}\text{C}$	0.6	IEC60584-1 ¹
	$+1000.0^{\circ}\text{C} \leq t \leq +2315.0^{\circ}\text{C}$	$0.6+(t-1000) \times 0.06\%$	
XK	$-200.0^{\circ}\text{C} \leq t < 0.0^{\circ}\text{C}$	$0.2+ t \times 0.10\%$	GOST R 8.585-2001
	$0.0^{\circ}\text{C} \leq t < +300.0^{\circ}\text{C}$	0.2	
	$+300.0^{\circ}\text{C} \leq t \leq +800.0^{\circ}\text{C}$	0.3	
A	$0.0^{\circ}\text{C} \leq t < +1000.0^{\circ}\text{C}$	0.8	IEC60584-1
	$+1000.0^{\circ}\text{C} \leq t \leq +2500.0^{\circ}\text{C}$	$0.8+(t-1000) \times 0.06\%$	
D (W3Re/W25Re)	$0.0^{\circ}\text{C} \leq t < +300.0^{\circ}\text{C}$	1.2	ASTM E1751/ E1751M
	$+300.0^{\circ}\text{C} \leq t < +1500.0^{\circ}\text{C}$	1.0	
	$+1500.0^{\circ}\text{C} \leq t \leq +2315.0^{\circ}\text{C}$	1.6	

Thermocouple	Accuracy (1 year, t: source temperature)		Specification
	Temperature Range	Source Accuracy \pm [°C]	
G (W/W26Re)	$+100.0^{\circ}\text{C} \leq t < +300.0^{\circ}\text{C}$	1.2	ASTM E1751/ E1751M
	$+300.0^{\circ}\text{C} \leq t < +1500.0^{\circ}\text{C}$	1.0	
	$+1500.0^{\circ}\text{C} \leq t \leq +2315.0^{\circ}\text{C}$	1.6	
PLATINEL II	$0.0^{\circ}\text{C} \leq t < +100.0^{\circ}\text{C}$	0.4	ASTM E1751/ E1751M
	$+100.0^{\circ}\text{C} \leq t < +1000.0^{\circ}\text{C}$	0.6	
	$+1000.0^{\circ}\text{C} \leq t \leq +1395.0^{\circ}\text{C}$	0.8	
PR20-40	$0.0^{\circ}\text{C} \leq t < +500.0^{\circ}\text{C}$	10.0	ASTM E1751
	$+500.0^{\circ}\text{C} \leq t < +1000.0^{\circ}\text{C}$	3.0	
	$+1000.0^{\circ}\text{C} \leq t \leq +1888.0^{\circ}\text{C}$	2.0	

Accuracy guaranteed under $+23^{\circ}\text{C} \pm 5^{\circ}\text{C}$, 20 to 80%RH

Add a temperature coefficient of $0.05^{\circ}\text{C}/^{\circ}\text{C}$ for -10°C to $+18^{\circ}\text{C}$ and $+28^{\circ}\text{C}$ to $+50^{\circ}\text{C}$.

Display resolution of source/measured values: 0.1°C

Accuracy when using the included binding post (99045).

1 Complies also with JIS C 1602

2 The setting can be changed to comply with IPTS-68 (JIS C 1602 1981).

Measurement Accuracy (common to CA500 and CA550)

Thermocouple	Accuracy (1 year, t: measurement temperature)		Specification
	Temperature Range	Measurement Accuracy \pm [°C]	
K	$-200.0^{\circ}\text{C} \leq t < 0.0^{\circ}\text{C}$	$0.3 + t \times 0.20\%$	IEC60584-1 ^{1, 2}
	$0.0^{\circ}\text{C} \leq t < +500.0^{\circ}\text{C}$	0.3	
	$+500.0^{\circ}\text{C} \leq t \leq +1372.0^{\circ}\text{C}$	$0.3 + (t - 500) \times 0.02\%$	
E	$-250.0^{\circ}\text{C} \leq t < -200.0^{\circ}\text{C}$	$0.3 + t \times 0.30\%$	IEC60584-1 ^{1, 2}
	$-200.0^{\circ}\text{C} \leq t < 0.0^{\circ}\text{C}$	$0.3 + t \times 0.30\%$	
	$0.0^{\circ}\text{C} \leq t < +500.0^{\circ}\text{C}$	0.3	
	$+500.0^{\circ}\text{C} \leq t \leq +1000.0^{\circ}\text{C}$	$0.3 + (t - 500) \times 0.02\%$	
J	$-210.0^{\circ}\text{C} \leq t < 0.0^{\circ}\text{C}$	$0.3 + t \times 0.20\%$	IEC60584-1 ^{1, 2}
	$0.0^{\circ}\text{C} \leq t \leq +1200.0^{\circ}\text{C}$	$0.3 + t \times 0.02\%$	
T	$-250.0^{\circ}\text{C} \leq t < -200.0^{\circ}\text{C}$	$0.7 + (t - 200) \times 1.00\%$	IEC60584-1 ^{1, 2}
	$-200.0^{\circ}\text{C} \leq t < 0.0^{\circ}\text{C}$	$0.3 + t \times 0.20\%$	
	$0.0^{\circ}\text{C} \leq t \leq +400.0^{\circ}\text{C}$	0.3	
N	$-200.0^{\circ}\text{C} \leq t < 0.0^{\circ}\text{C}$	$0.5 + t \times 0.20\%$	IEC60584-1 ¹
	$0.0^{\circ}\text{C} \leq t \leq +1300.0^{\circ}\text{C}$	0.5	
L	$-200.0^{\circ}\text{C} \leq t < 0.0^{\circ}\text{C}$	$0.3 + t \times 0.10\%$	DIN 43710 1985
	$0.0^{\circ}\text{C} \leq t \leq +900.0^{\circ}\text{C}$	0.3	
U	$-200.0^{\circ}\text{C} \leq t < 0.0^{\circ}\text{C}$	$0.3 + t \times 0.10\%$	DIN 43710 1985
	$0.0^{\circ}\text{C} \leq t \leq +600.0^{\circ}\text{C}$	0.3	
R	$-20.0^{\circ}\text{C} \leq t < 0.0^{\circ}\text{C}$	1.8	IEC60584-1 ^{1, 2}
	$0.0^{\circ}\text{C} \leq t < +100.0^{\circ}\text{C}$	1.2	
	$+100.0^{\circ}\text{C} \leq t \leq +1767.0^{\circ}\text{C}$	1.2	

5. Specifications

Thermocouple	Accuracy (1 year, t: measurement temperature)		Specification
	Temperature Range	Measurement Accuracy \pm [°C]	
S	$-20.0^{\circ}\text{C} \leq t < 0.0^{\circ}\text{C}$	1.8	IEC60584-1 ^{1, 2}
	$0.0^{\circ}\text{C} \leq t < +100.0^{\circ}\text{C}$	1.2	
	$+100.0^{\circ}\text{C} \leq t \leq +1768.0^{\circ}\text{C}$	1.2	
B	$+600.0^{\circ}\text{C} \leq t < +800.0^{\circ}\text{C}$	1.3	IEC60584-1 ^{1, 2}
	$+800.0^{\circ}\text{C} \leq t < +1000.0^{\circ}\text{C}$	1.0	
	$+1000.0^{\circ}\text{C} \leq t \leq +1820.0^{\circ}\text{C}$	0.9	
C	$0.0^{\circ}\text{C} \leq t < +1000.0^{\circ}\text{C}$	0.6	IEC60584-1 ¹
	$+1000.0^{\circ}\text{C} \leq t \leq +2315.0^{\circ}\text{C}$	$0.6 + (t-1000) \times 0.06\%$	
XK	$-200.0^{\circ}\text{C} \leq t < 0.0^{\circ}\text{C}$	$0.2 + t \times 0.10\%$	GOST R 8.585-2001
	$0.0^{\circ}\text{C} \leq t < +300.0^{\circ}\text{C}$	0.2	
	$+300.0^{\circ}\text{C} \leq t \leq +800.0^{\circ}\text{C}$	0.3	
A	$0.0^{\circ}\text{C} \leq t < +1000.0^{\circ}\text{C}$	0.8	IEC60584-1
	$+1000.0^{\circ}\text{C} \leq t \leq +2500.0^{\circ}\text{C}$	$0.8 + (t-1000) \times 0.06\%$	
D (W3Re/W25Re)	$0.0^{\circ}\text{C} \leq t < +300.0^{\circ}\text{C}$	1.6	ASTM E1751/ E1751M
	$+300.0^{\circ}\text{C} \leq t < +1500.0^{\circ}\text{C}$	1.0	
	$+1500.0^{\circ}\text{C} \leq t \leq +2315.0^{\circ}\text{C}$	2.0	
G (W/W26Re)	$+100.0^{\circ}\text{C} \leq t < +300.0^{\circ}\text{C}$	1.6	ASTM E1751/ E1751M
	$+300.0^{\circ}\text{C} \leq t < +1500.0^{\circ}\text{C}$	1.0	
	$+1500.0^{\circ}\text{C} \leq t \leq +2315.0^{\circ}\text{C}$	2.0	
PLATINEL II	$0.0^{\circ}\text{C} \leq t < +100.0^{\circ}\text{C}$	1.6	ASTM E1751/ E1751M
	$+100.0^{\circ}\text{C} \leq t < +1000.0^{\circ}\text{C}$	1.6	
	$+1000.0^{\circ}\text{C} \leq t \leq +1395.0^{\circ}\text{C}$	2.0	
PR20-40	$0.0^{\circ}\text{C} \leq t < +500.0^{\circ}\text{C}$	11.0	ASTM E1751
	$+500.0^{\circ}\text{C} \leq t < +1000.0^{\circ}\text{C}$	4.0	
	$+1000.0^{\circ}\text{C} \leq t \leq +1888.0^{\circ}\text{C}$	2.0	

Accuracy guaranteed under $+23^{\circ}\text{C} \pm 5^{\circ}\text{C}$, 20 to 80%RH

Add a temperature coefficient of $0.05^{\circ}\text{C}/^{\circ}\text{C}$ for -10°C to $+18^{\circ}\text{C}$ and $+28^{\circ}\text{C}$ to $+50^{\circ}\text{C}$.

Display resolution of source/measured values: 0.1°C

Accuracy when using the included binding post (99045).

1 Complies also with JIS C 1602

2 The setting can be changed to comply with IPTS-68 (JIS C 1602 1981).

Common Specifications

Source/measurement temperature to voltage conversion function

Terminal type selection function: TC-A/TC-B terminal

Temperature monitor function: Temperature measurement of the reference junction compensation sensor for the selected terminal type

Reference junction compensation function: Can be disabled when using the TC-B terminal

An external reference junction compensation sensor can be selected when using the TC-B terminal.

Burnout detection function: Turns burnout detection on and off (during measurement)

Reference junction compensation sensor: NTC thermistor (TC-A, TC-B)

Temperature scale selection function: ITS-90/IPTS68

TC types K, E, J, T, R, S, and B can also handle the IPTS-68 temperature scale.

External RJ Sensor 90080 (sold separately) Specifications

Used sensor: RTD Pt100 (four-wire system)

Standalone accuracy: JIS AA class or equivalent

Regulation current: 1 mA

Operating temperature range: -10°C to 55°C

Y terminal: M3 screw compatible

5.4 Temperature Measurement (RTD) and Resistance Source for RTD Calibration

CA500

RTD	Coef	Source/measurement accuracy (1 year, t: source/measurement temperature)		Allowable Excitation Current	Standard, Citation
		Temperature Range	CA500 \pm [°C]		
PT100	3851	$-200.0^{\circ}\text{C} \leq t < +100.0^{\circ}\text{C}$	0.3	0.1 to 3 mA	IEC60751 ¹
		$+100.0^{\circ}\text{C} \leq t \leq +800.0^{\circ}\text{C}$	$0.3+(t-100) \times 0.033\%$		
	3850	$-200.0^{\circ}\text{C} \leq t < +100.0^{\circ}\text{C}$	0.3	0.1 to 3 mA	JIS C 1604 1989 (Pt100)
		$+100.0^{\circ}\text{C} \leq t \leq +630.0^{\circ}\text{C}$	$0.3+(t-100) \times 0.033\%$		
	3916	$-200.0^{\circ}\text{C} \leq t < +100.0^{\circ}\text{C}$	0.3	0.1 to 3 mA	JIS C 1604 1989 (JPT100)
		$+100.0^{\circ}\text{C} \leq t \leq +510.0^{\circ}\text{C}$	$0.3+(t-100) \times 0.033\%$		
	3926	$-200.0^{\circ}\text{C} \leq t < +100.0^{\circ}\text{C}$	0.3	0.1 to 3 mA	Minco Application Aid #18
		$+100.0^{\circ}\text{C} \leq t \leq +630.0^{\circ}\text{C}$	$0.3+(t-100) \times 0.033\%$		
PT200	3851	$-200.0^{\circ}\text{C} \leq t < +100.0^{\circ}\text{C}$	0.3	0.05 to 3 mA	IEC60751 ¹
		$+100.0^{\circ}\text{C} \leq t \leq +630.0^{\circ}\text{C}$	$0.3+(t-100) \times 0.033\%$		
PT500	3851	$-200.0^{\circ}\text{C} \leq t < +100.0^{\circ}\text{C}$	0.3	0.05 to 0.6 mA	IEC60751 ¹
		$+100.0^{\circ}\text{C} \leq t \leq +630.0^{\circ}\text{C}$	$0.3+(t-100) \times 0.033\%$		
PT1000	3851	$-200.0^{\circ}\text{C} \leq t < +100.0^{\circ}\text{C}$	0.2	0.05 to 0.6 mA	IEC60751 ¹
		$+100.0^{\circ}\text{C} \leq t \leq +630.0^{\circ}\text{C}$	$0.2+(t-100) \times 0.033\%$		
Cu10	427	$-100.0^{\circ}\text{C} \leq t \leq +260.0^{\circ}\text{C}$	1.5	0.1 to 3 mA	Minco Application Aid #18
Ni120	627	$-80.0^{\circ}\text{C} \leq t \leq +260.0^{\circ}\text{C}$	0.2	0.1 to 3 mA	Minco Application Aid #18
PT50	3851	$-200.0^{\circ}\text{C} \leq t < +100.0^{\circ}\text{C}$	0.4	0.1 to 3 mA	IEC60751 ¹
		$+100.0^{\circ}\text{C} \leq t \leq +630.0^{\circ}\text{C}$	$0.4+(t-100) \times 0.033\%$		
PT50G	-	$-200.0^{\circ}\text{C} \leq t < +100.0^{\circ}\text{C}$	0.4	0.1 to 3 mA	GOST R 8.625-2006
		$+100.0^{\circ}\text{C} \leq t \leq +800.0^{\circ}\text{C}$	$0.4+(t-100) \times 0.033\%$		
PT100G	-	$-200.0^{\circ}\text{C} \leq t < +100.0^{\circ}\text{C}$	0.3	0.1 to 3 mA	GOST R 8.625-2006
		$+100.0^{\circ}\text{C} \leq t \leq +630.0^{\circ}\text{C}$	$0.3+(t-100) \times 0.033\%$		
Cu50M	-	$-180.0^{\circ}\text{C} \leq t \leq +200.0^{\circ}\text{C}$	0.4	0.1 to 3 mA	GOST R 8.625-2006
Cu100M	-	$-180.0^{\circ}\text{C} \leq t \leq +200.0^{\circ}\text{C}$	0.3	0.1 to 3 mA	GOST R 8.625-2006

Accuracy guaranteed under $+23^{\circ}\text{C}\pm 5^{\circ}\text{C}$, 20 to 80%RH
 Add a temperature coefficient of $0.05^{\circ}\text{C}/^{\circ}\text{C}$ for -10°C to $+18^{\circ}\text{C}$ and $+28^{\circ}\text{C}$ to $+50^{\circ}\text{C}$.

Accuracies through four-wire system measurement

For accuracies through three-wire system measurement, add 1.0°C for Cu10, 0.6°C for Pt50, Pt50G, and Cu50M, and 0.3°C for other RTDs. However, this assumes that the resistances of all cables are the same.

Assume the accuracies through two-wire system measurement to be the same as those through three-wire system measurement. However, cable resistance are not taken into consideration.

Display resolution of source/measured values: 0.1°C

1 Complies also with JIS C 1604

CA550

RTD	Coef	Source/measurement accuracy (1 year, t: source/measurement temperature)		Allowable Excitation Current	Standard, Citation
		Temperature Range	CA550 \pm [$^{\circ}\text{C}$]		
PT100	3851	$-200.0^{\circ}\text{C} \leq t < +100.0^{\circ}\text{C}$	0.1	0.1 to 3 mA	IEC60751 ¹
		$+100.0^{\circ}\text{C} \leq t \leq +800.0^{\circ}\text{C}$	$0.1+(t-100) \times 0.033\%$		
	3850	$-200.0^{\circ}\text{C} \leq t < +100.0^{\circ}\text{C}$	0.1	0.1 to 3 mA	JIS C 1604 1989 (Pt100)
		$+100.0^{\circ}\text{C} \leq t \leq +630.0^{\circ}\text{C}$	$0.1+(t-100) \times 0.033\%$		
	3916	$-200.0^{\circ}\text{C} \leq t < +100.0^{\circ}\text{C}$	0.1	0.1 to 3 mA	JIS C 1604 1989 (JPt100)
		$+100.0^{\circ}\text{C} \leq t \leq +510.0^{\circ}\text{C}$	$0.1+(t-100) \times 0.033\%$		
	3926	$-200.0^{\circ}\text{C} \leq t < +100.0^{\circ}\text{C}$	0.1	0.1 to 3 mA	Minco Application Aid #18
		$+100.0^{\circ}\text{C} \leq t \leq +630.0^{\circ}\text{C}$	$0.1+(t-100) \times 0.033\%$		
PT200	3851	$-200.0^{\circ}\text{C} \leq t < +100.0^{\circ}\text{C}$	0.1	0.05 to 3 mA	IEC60751 ¹
		$+100.0^{\circ}\text{C} \leq t \leq +630.0^{\circ}\text{C}$	$0.1+(t-100) \times 0.033\%$		
PT500	3851	$-200.0^{\circ}\text{C} \leq t < +100.0^{\circ}\text{C}$	0.1	0.05 to 0.6 mA	IEC60751 ¹
		$+100.0^{\circ}\text{C} \leq t \leq +630.0^{\circ}\text{C}$	$0.1+(t-100) \times 0.033\%$		
PT1000	3851	$-200.0^{\circ}\text{C} \leq t < +100.0^{\circ}\text{C}$	0.1	0.05 to 0.6 mA	IEC60751 ¹
		$+100.0^{\circ}\text{C} \leq t \leq +630.0^{\circ}\text{C}$	$0.1+(t-100) \times 0.033\%$		
Cu10	427	$-100.0^{\circ}\text{C} \leq t \leq +260.0^{\circ}\text{C}$	1.2	0.1 to 3 mA	Minco Application Aid #18
Ni120	627	$-80.0^{\circ}\text{C} \leq t \leq +260.0^{\circ}\text{C}$	0.1	0.1 to 3 mA	Minco Application Aid #18
PT50	3851	$-200.0^{\circ}\text{C} \leq t < +100.0^{\circ}\text{C}$	0.2	0.1 to 3 mA	IEC60751 ¹
		$+100.0^{\circ}\text{C} \leq t \leq +630.0^{\circ}\text{C}$	$0.2+(t-100) \times 0.033\%$		

5. Specifications

RTD	Coef	Source/measurement accuracy (1 year, t: source/measurement temperature)		Allowable Excitation Current	Standard, Citation
		Temperature Range	CA550 ±[°C]		
PT50G	-	-200.0°C ≤ t < +100.0°C	0.2	0.1 to 3 mA	GOST R 8.625-2006
		+100.0°C ≤ t ≤ +800.0°C	0.2+(t-100)x 0.033%		
PT100G	-	-200.0°C ≤ t < +100.0°C	0.1	0.1 to 3 mA	GOST R 8.625-2006
		+100.0°C ≤ t ≤ +630.0°C	0.1+(t-100)x 0.033%		
Cu50M	-	-180.0°C ≤ t ≤ +200.0°C	0.2	0.1 to 3 mA	GOST R 8.625-2006
Cu100M	-	-180.0°C ≤ t ≤ +200.0°C	0.1	0.1 to 3 mA	GOST R 8.625-2006

Accuracy guaranteed under +23°C±5°C, 20 to 80%RH

Add a temperature coefficient of 0.05°C/°C for -10°C to +18°C and +28°C to +50°C.

Accuracies through four-wire system measurement

For accuracies through three-wire system measurement, add 1.0°C for Cu10, 0.6°C for Pt50, Pt50G, and Cu50M, and 0.3°C for other RTDs. However, this assumes that the resistances of all cables are the same.

Assume the accuracies through two-wire system measurement to be the same as those through three-wire system measurement. However, cable resistance are not taken into consideration.

Display resolution of source/measured values: 0.1°C

1 Complies also with JIS C 1604

Source Section

- Resistance value conversion function
- Overcurrent input warning: When the upper of allowable excitation current is exceeded
- The source accuracy is defined for the following conditions.
 - The included binding post (99045) is used to source the signal.
 - The specified cable is used to source the signal.
 - The effect of the voltage drop in the cable is excluded.
 - The effect of the aging of the instrument is excluded.

Measurement Section

- Wiring system: Select 2W, 3W, or 4W.
- Burnout detection: Only the measurement cable on the HI side is detected.
- Measurement current: 1 mA (0 Ω), 781 μA (400 Ω), 240 μA (4 kΩ)
- Allowable cable resistance: 10 Ω or less

5.5 Common Specifications

Common Source Section Specifications

Source section voltage limiter	Approx. -5 V to 36 V
Source section current limiter	Approx. 30 mA
Sweep function	Step/Linear/Programr
Interval time	5 to 600 s
Maximum load	$C \leq 10 \mu\text{F}$, $L \leq 10 \text{ mH}$
Output resistance	20 m Ω or less
Output response	
DC Voltage/DC Current/TC:	Approx. 250 ms
RTD/Resistance:	Approx. 1 ms

Common Measurement Section Specifications

CMRR:	120 dB (50/60 Hz)
NMRR:	60 dB (50/60 Hz)
Rating between terminals:	Between H/L terminals: 50 V
	Between LOOP/mA terminals: 30 V
	Between mA/L terminals: 50 mA
Current terminal input protection:	PTC protection
Maximum voltage application between measurement terminals and earth:	50Vpeak

5. Specifications

5.6 General Specifications

Item		Specifications
Operating environment	Ambient temp	-10 to +50°C
	Ambient humidity	80%RH or less for -10 to 40°C (no condensation) 50%RH or less for over 40°C to 50°C (no condensation)
	Altitude	2000 m or less
Storage environment	Ambient temp	-20 to 60°C
	Ambient humidity	90%RH or less (no condensation)
Display		Monochrome dot matrix LCD ¹
Built-in light		Select always on, always off, or off approximately 10 minutes after last operation. With a light control function
Display update rate		Approx. 1 s
Warm-up time		Approx. 5 minutes
Language		English (default), Japanese, Chinese, Korean, Russian
Battery		DC 5 V ± 10%, Maximum 500 mA, Four AA alkaline batteries Battery life: Approx. 16 hours (measurement ON, 5V output/10kΩ or more)
Auto power-off		Approx. 30 minutes (default value: disabled)
Maximum voltage application between terminals and earth		Measurement terminal: 50 V, source terminal: 30 V
Insulation resistance		Between FUNCTION1 terminal and FUNCTION2 terminal: At least 50 MΩ (500 VDC)
Withstand voltage		Between FUNCTION1 terminal and FUNCTION2 terminal: 500 VAC for 10 seconds
Number of Saved Data Values		CA500: Up to 100 results CA550: Up to 250 CSV files
Interface		CA500: USB B Communication Device Class CA550: USB B Communication Device Class USB B Mass Storage Class
Dimensions		Approx. 130 (W) × 260 (H) × 53 (D) mm
Weight		Approx. 900 g (including batteries)
Safety standards		EN 61010-1 Overvoltage Category I ² Pollution degree 2 ³ EN 61010-2-030 Measurement Category Other (O)

Item		Specifications
EMC	Emissions	<p>Compliant standards: EN 61326-1 Class A, EN 55011 Class A Group1 EMC Regulatory Arrangement in Australia and New Zealand EN 55011 Class A, Group 1 Korea Electromagnetic Conformity Standard (한국 전자파적합성기준) This product is classified as Class A (for use in industrial environments). Operation of this product in a residential area may cause radio interference, in which case the user will be required to correct the interference.</p> <p>Cable conditions</p> <p>Output terminal Use the included measurement leads (98020; length: 1.7 m).</p> <p>Measurement terminal Use the included measurement leads (98035; length: 1.7 m).</p> <p>External RJC terminal Use the 90080 (length: 1.5 m), sold separately.</p> <p>TC mini plug terminal Use the 90040 or 90045, sold separately. Cable length: 1.7 m</p> <p>USB port Use a shielded USB cable (3 m in length or less).</p>
	Immunity	<p>Compliant standard: EN 61326-1 Table2 (for use in industrial locations) Influence in the immunity test environment: Within $\pm 10\%$ of the range setting</p> <p>Cable conditions</p> <p>Measurement terminal Short</p> <p>External RJC terminal Short</p> <p>TC mini plug termina Short</p> <p>HART-BRAIN communication Use a shielded cable, and connect the shield to the external RJ sensor shell.</p> <p>Cable conditions other than the above are the same as the cable conditions for emissions.</p>
Environmental standard	Compliant standard: EN50581 Monitoring and control instruments including those for industrial use	

- 1 The LCD may include a few defective pixels (within 2 points over the total number of pixels). The LCD may contain some pixels that are always illuminated or that never light. Please be aware that these are not defects.
- 2 The overvoltage category (installation category) is a value used to define the transient overvoltage condition and includes the rated impulse withstand voltage. Overvoltage Category I applies to equipment that is connected to a circuit that has been designed to suppress overvoltage caused by transient phenomena to an adequately low level.
- 3 Pollution Degree applies to the degree of adhesion of a solid, liquid, or gas that deteriorates withstand voltage or surface resistivity. Pollution degree 2 applies to normal indoor atmospheres (with only non-conductive pollution).

5. Specifications

External Dimensions

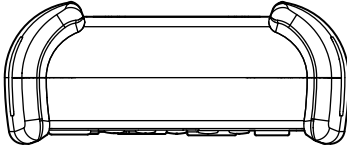

Unit: mm

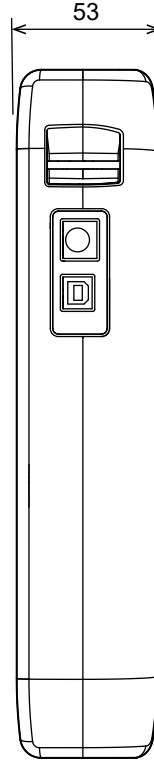
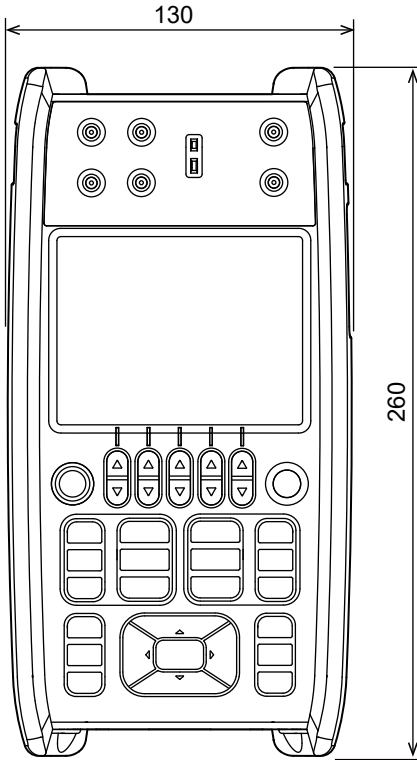

Unless otherwise specified, tolerances are $\pm 3\%$ (however, tolerances are ± 0.3 mm when below 10 mm).