

Electrical Safety Analyzer

GPT-10000 Series

USER MANUAL



ISO-9001 CERTIFIED MANUFACTURER

GW INSTEK

This manual contains proprietary information, which is protected by copyright. All rights are reserved. No part of this manual may be photocopied, reproduced or translated to another language without prior written consent of Good Will company.

The information in this manual was correct at the time of printing. However, Good Will continues to improve products and reserves the rights to change specification, equipment, and maintenance procedures at any time without notice.

Good Will Instrument Co., Ltd.
No. 7-1, Jhongsing Rd., Tucheng Dist., New Taipei City 236, Taiwan.

Table of Contents

SAFETY INSTRUCTIONS	5
GETTING STARTED.....	9
GPT-12000 Series Overview	10
Front Panel Overview	14
Rear Panel Overview	18
Set Up.....	21
OPERATION	28
Menu Tree.....	30
Test Lead Connection.....	35
Manual Tests	38
Special MANU Test Mode (000)	88
Sweep Function.....	90
Automatic Tests	93
System Settings	117
EXTERNAL CONTROL	157
External Control Overview.....	158
REMOTE CONTROL.....	164
Interface Configuration	165
Command Syntax	169
Command List	172
Error Messages.....	228
FAQ.....	229
APPENDIX.....	232
Fuse Replacement.....	232
Tester Errors	233

GPT-12000 Specifications	235
GPT-12001/12002/12003 Dimensions	241
GPT-12004 Dimensions.....	242
Declaration of Conformity.....	243
INDEX.....	244

S SAFETY INSTRUCTIONS

This chapter contains important safety instructions that you must follow during operation and storage. Read the following before any operation to ensure your safety and to keep the instrument in the best possible condition.

Safety Symbols

These safety symbols may appear in this manual or on the instrument.



WARNING

Warning: Identifies conditions or practices that could result in injury or loss of life.



CAUTION

Caution: Identifies conditions or practices that could result in damage to the instrument or to other properties.



DANGER High Voltage



Attention Refer to the Manual



Protective Conductor Terminal



Frame or Chassis Terminal



Earth (ground) Terminal



Do not dispose electronic equipment as unsorted municipal waste. Please use a separate collection facility or contact the supplier from which this instrument was purchased.

Safety Guidelines

General Guideline



CAUTION

- Do not place any heavy object on the instrument.
- Avoid severe impact or rough handling that leads to damaging the instrument.
- Do not discharge static electricity to the instrument.
- Use only mating connectors, not bare wires, for the terminals.
- Do not block the cooling fan opening.
- Do not disassemble the GPT-10000 unless you are qualified.

Position Guideline



WARNING

- The rear position of the GPT-10000 should be placed in an area with easy accessible for power disconnection, that is, unplugging the power cord with ease.
- Keep away from the device under test which connects with the GPT-10000 when test is underway. In addition, while test is ongoing, never touch the device under test, the GPT-10000 as well as other relevant units.
- Any inappropriate manner that is unspecified by the manufacturer may result in irreversible harms or impaired protection by the GPT-10000.

(Measurement categories) EN 61010-1:2010 specifies the measurement categories and their requirements as follows. The GPT-10000 does not fall under category II, III or IV.

- Measurement category IV is for measurement performed at the source of low-voltage installation.
- Measurement category III is for measurement performed in the building installation.
- Measurement category II is for measurement performed on the circuits directly connected to the low voltage installation.

Power Supply



WARNING

- AC Input voltage range:
AC 100V – 240V \pm 10%
- Frequency: 50Hz/60Hz
- To avoid electrical shock connect the protective grounding conductor of the AC power cord to an earth ground.

Cleaning the GPT-10000

- Disconnect the power cord before cleaning.
- Use a soft cloth dampened in a solution of mild detergent and water. Do not spray any liquid.
- Do not use chemicals containing harsh material such as benzene, toluene, xylene, and acetone.

Operation Environment

- Location: Indoor, no direct sunlight, dust free, almost non-conductive pollution (Note below)
- Relative Humidity: \leq 70% (no condensation)
- Altitude: < 2000m
- Temperature: 0°C~40°C

(Pollution Degree) EN 61010-1:2010 specifies the pollution degrees and their requirements as follows. The GPT-10000 falls under degree 2.

Pollution refers to “addition of foreign matter, solid, liquid, or gaseous (ionized gases), that may produce a reduction of dielectric strength or surface resistivity”.

- Pollution degree 1: No pollution or only dry, non-conductive pollution occurs. The pollution has no influence.
- Pollution degree 2: Normally only non-conductive pollution occurs. Occasionally, however, a temporary conductivity caused by condensation must be expected.
- Pollution degree 3: Conductive pollution occurs, or dry, non-conductive pollution occurs which becomes conductive due to condensation which is expected. In such conditions, equipment is normally protected against exposure to direct sunlight, precipitation, and full wind pressure, but neither temperature nor humidity is controlled.

Storage environment

- Location: Indoor
- Temperature: -10°C to 70°C
- Relative Humidity: ≤ 85% (no condensation)

Disposal



Do not dispose this instrument as unsorted municipal waste. Please use a separate collection facility or contact the supplier from which this instrument was purchased. Please make sure discarded electrical waste is properly recycled to reduce environmental impact.

G E T T I N G S T A R T E D

This chapter describes the safety analyzer in a nutshell, including its main features and front / rear panel introduction. After going through the overview, please read the safety considerations in the Set Up chapter.

GPT-12000 Series Overview	10
Series lineup	10
Lineup Overview	11
Main Features	11
Accessories	12
Package Contents	13
Front Panel Overview	14
GPT-12001/12002/12003/12004	14
Rear Panel Overview	18
GPT-12001/12002/12003/12004	18
Set Up	21
Tilting the Stand	21
Line Voltage Connection and Power Up	22
Installing the Optional GPIB Card	23
Workplace Precautions	24
Operating Precautions	25
Basic Safety Checks	27

GPT-12000 Series Overview

Series lineup

The GPT-12000 Series Safety Analyzers are AC/DC withstanding voltage, insulation resistance, ground bond and continuity safety analyzers.

The GPT-12001 is AC withstanding voltage and continuity tester, the GPT-12002 is AC/DC withstanding voltage and continuity tester and the GPT-12003 is AC/DC withstanding voltage, insulation resistance and continuity tester. The GPT-12004 includes all the test functions of the previous models, plus the ground bond testing. Also, for the all the models, the testing terminals are also mirrored on the rear panel for added safety and for more permanent safety testing environments.

The GPT-12000 Series can store up to 100 manual tests, as well as run up to 10 manual tests sequentially as an automatic test, allowing the safety analyzers to accommodate any number of safety standards, including IEC, EN, UL, CSA, GB, JIS and others.

Note: Throughout this user manual, the terms ACW, DCW, IR, GB and CONT refer to AC Withstanding, DC Withstanding, Insulation Resistance, Ground Bond and Continuity testing, respectively.

Lineup Overview

Model name	ACW	DCW	IR	GB	CONT
GPT-12001	✓				✓
GPT-12002	✓	✓			✓
GPT-12003	✓	✓	✓		✓
GPT-12004	✓	✓	✓	✓	✓

Main Features

Performance

- ACW: 5kVAC
- DCW: 6kVDC
- IR: 50V~1200V (50V steps)*
- GB: 3A~32A
- CONT: 100mA

Features

- Ramp up time control
- Ramp down time control
- Safety discharge
- 100 test conditions (MANU mode)
- 100 automatic tests (AUTO mode)
- Over temperature, voltage and current protection
- Pass, Fail, Test, High Voltage and Ready indicators
- PWM output (90% efficiency, increased reliability)
- Interlock (configurable)
- Rear panel output

- Interface
- Remote control start/stop interface terminal
 - RS232/USB interface for programming
 - Optional GPIB interface for programming
 - Signal I/O port for pass/fail/test monitoring and start/stop control/interlock

Accessories

Standard Accessories	Part number	Description
	GHT-115x1	Test lead
	Region dependent	Power cord
	GTL-215x1	GB test lead (GPT-12004 only)
	GHT-119	Remote terminal cable
	N/A	Interlock key
Optional Accessories	Part number	Description
	GHT-205	High Voltage Test Probe
	GHT-113	High Voltage Test Pistol
	GTL-232	RS232C cable
	GTL-248	GPIB cable
	GTL-246	USB cable (A to B type)
Options	Part number	Description
	Opt.01 GPIB Interface	GPIB module

Package Contents

Check the contents before using the GPT-12000 series.

Opening the box

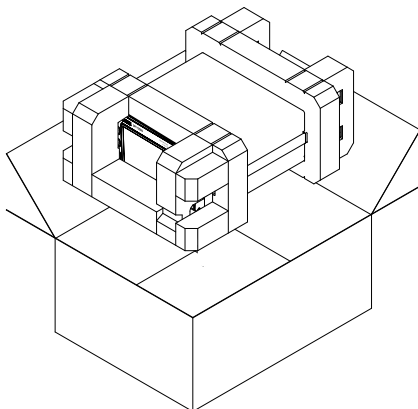

Contents (single unit)

- GPT-12000 unit
- Quick Start Guide
- User manual CD
- CTC (Calibration Traceable Certificate)
- Power cord x1 (region dependent)
- GHT-115 test leads x1
- GTL-215 GB test leads x1 (GPT-12004)
- GHT-119 Remote terminal cable
- Interlock key



Keep the packaging, including the box, polystyrene foam and plastic envelopes should the need arise to return the unit to GW Instek.

Front Panel Overview

GPT-12001/12002/12003/12004

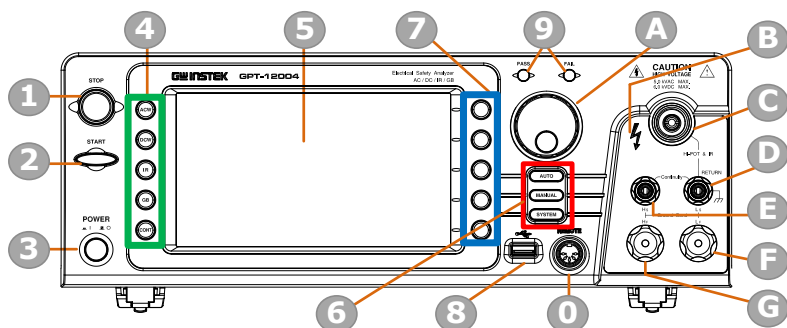

Item	Description
1	STOP Button
2	START Button
3	POWER Switch
4	Test Function Keys (Green Zone)
5	Display
6	Mode Keys (AUTO, MANUAL, SYSTEM in Red Zone)
7	Soft Keys (Blue Zone)
8	USB A-Type Host Port
9	PASS/FAIL Indicators
0	REMOTE Terminal
A	Scroll Wheel
B	HIGH VOLTAGE Indicator
C	HIGH VOLTAGE Output Terminal
D	SENSE L & RETURN Terminal
E	SENSE H & Output Terminal
F	SOURCE L (GPT-12004 only)
G	SOURCE H (GPT-12004 only)

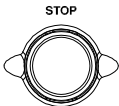
STOP button  The STOP button is used to stop/cancel tests. The STOP button will also put the safety analyzer in the READY status to begin testing.

START button  The START button is used to start tests. The START button can be used to start tests when the tester is in the READY status. Pressing the START button will put the tester in the TEST status.

POWER switch  Turns the power on. The safety analyzer will always start up with the last test setting from when the instrument was last powered down.

Test Function Keys The keys indicate the 5 testing functions including ACW, DCW, IR, GB and CONT. Pressing one of the keys enters the function settings.

Display 7" Color TFT LCD display in 800 X 480 resolution

AUTO button  Press to enter the AUTO test mode.

MANUAL button  Press to enter the MANUAL test mode.

SYSTEM button  Press to enter the SYSTEM mode.

Soft Keys The Soft keys correspond to the menu keys directly above on the main display.

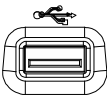
USB Host Port  It can connect with USB flash drive for data storage or barcode scanner for convenient tests.

Pass/Fail indicators

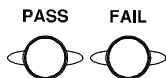

The PASS and FAIL indicators light up upon a PASS or FAIL test result at the end of a manual test or automatic test.

REMOTE terminal



The REMOTE terminal is used to connect to a remote controller.

Scroll wheel



The scroll wheel is used to edit parameter values.

HIGH VOLTAGE indicator



The HIGH VOLTAGE indicator will light up red when an output terminal is active. Only after the test has finished or stopped will the indicator turn off.

HIGH VOLTAGE output terminal

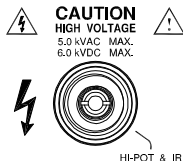

The HIGH VOLTAGE terminal output is used for outputting the testing voltage in ACW, DCW and IR tests. The terminal is recessed for safety. This terminal is used in conjunction with the RETURN terminal.

 **WARNING**

USE EXTREME CAUTION.
Do not touch the HIGH VOLTAGE terminal during testing.

RETURN terminal

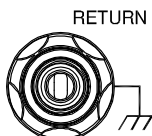

The RETURN terminal is used for ACW, DCW, IR and CONT tests.

OUTPUT and RETURN terminals

All models

The OUTPUT terminal (red) and RETURN terminal (black) are used for CONT (Continuity) test.

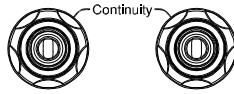

SENSE H/L and SOURCE H/L terminals

GPT-12004 only

The SENSE H, SENSE L, SOURCE H and SOURCE L, terminals are used for GB (Ground Bond) test.

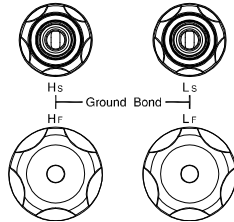

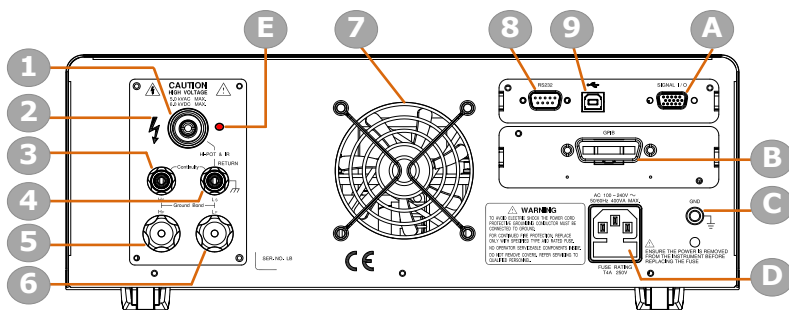

Rear Panel Overview

GPT-12001/12002/12003/12004



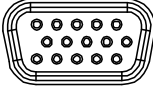

Item	Description
1	HIGH VOLTAGE Output Terminal
2	HIGH VOLTAGE Indicator
3	SENSE H & Output Terminal
4	SENSE L & RETURN Terminal
5	SOURCE H (GPT-12004 only)
6	SOURCE L (GPT-12004 only)
7	Fan
8	RS-232 Port
9	USB B-Type Interface Port
A	Signal I/O Port
B	GPIB Port (Optional)
C	GND
D	AC Mains Input (Power Cord Socket)
E	HIGH VOLTAGE pilot lamp

- SIGNAL I/O port **SIGNAL I/O** The SIGNAL I/O port is used to monitor the tester status (PASS, FAIL, TEST) and input (START/STOP signals). It is also used with the Interlock key.

- USB B-Type port  The USB B-Type port is used for remote control.

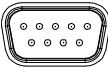
- RS232 interface port **RS232** The RS-232 port is used for remote control and firmware updates.

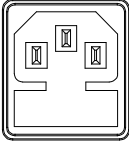

- Fan/Fan Vents  Exhaust fan. Allow enough room for the fan to vent. Do not block the fan openings.
- GND **GND** Connect the GND (ground) terminal to the earth ground.

- AC Mains Input **AC 100 - 240V ~
50/60Hz 400VA MAX.** AC Mains Input for Power Cord Socket: 100 - 240 VAC ±10%.

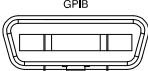

**FUSE RATING
T4A 250V**

The fuse holder contains the AC mains fuse. For fuse replacement details, see page 45.
- Optional GPIB port **GPIB** Optional GPIB interface for remote control.



HIGH VOLTAGE output terminal

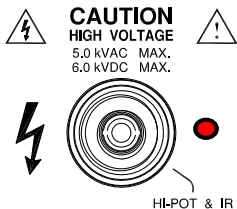

The HIGH VOLTAGE terminal output is used for outputting the testing voltage in ACW, DCW and IR tests. The terminal is recessed for safety and used in conjunction with the RETURN terminal.

WARNING

USE EXTREME CAUTION. Do not touch the HIGH VOLTAGE terminal during testing.

HIGH VOLTAGE pilot lamp



The HIGH VOLTAGE pilot lamp will light up red when an output terminal is active. Only after the test has finished or stopped will the lamp turn off.

RETURN terminal

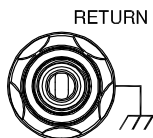

The RETURN terminal is used for ACW, DCW, IR and CONT tests.

OUTPUT and RETURN terminals

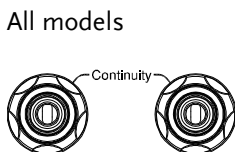

The OUTPUT terminal (red) and RETURN terminal (black) are used for CONT (Continuity) test.

SENSE H/L and SOURCE H/L terminals

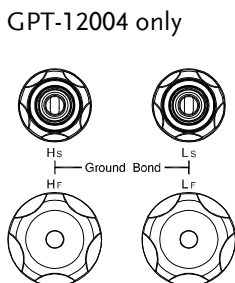

The SENSE H, SENSE L, SOURCE H and SOURCE L, terminals are used for GB (Ground Bond) test.

Set Up

Tilting the Stand

Horizontal position

Place the unit on a flat surface horizontally.

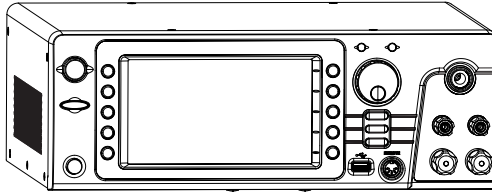

Tilt stand position

Gently pull the 2 stands out from the bottom and the unit will be placed in the tilt stand position.

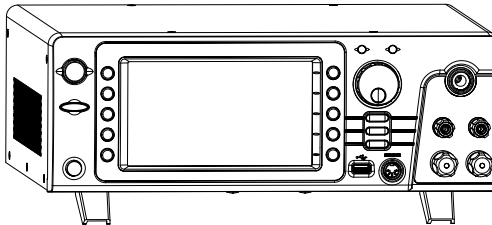

Line Voltage Connection and Power Up

Background The GPT-12000 accepts line voltages of 100 - 240V at 50Hz or 60Hz.

Steps 1. Connect the power cord to the AC Mains Input socket on the rear panel.

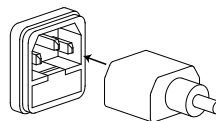

2. If the power cord does not have an earth ground, ensure the ground terminal is connected to an earth ground.

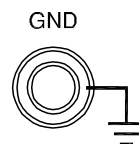

Ensure the power cord is connected to an earth ground. Failure could be harmful to the operator and instrument.

3. Press the Power button.

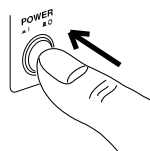

4. When the unit is powered up, the display will show the last time parameters in either MANU or AUTO test mode as shown below.



Installing the Optional GPIB Card

Background The optional GPIB is a user-installable option. Follow the instructions below to install the GPIB card.



WARNING

Before installing optional GPIB card ensure the GPT-12000 is turned off and disconnected from power.

Steps

1. Remove screws from the rear panel cover plate.

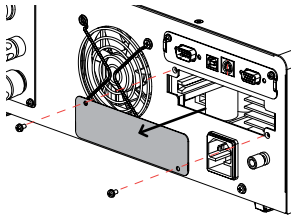

2. Insert the GPIB card into the opening of rear panel. Push the card gently until it is fully inserted followed by fastening the screws.

GPIB Card

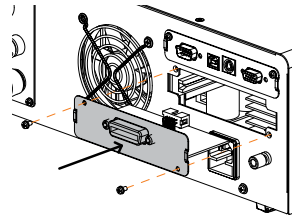

Workplace Precautions

Background The GPT-12000 is a high voltage instrument that outputs dangerous voltages. The following section describes precautions and procedures that must be followed to ensure a safe work environment.



WARNING

The GPT-12000 generates voltages in excess of 5kVAC or 6kVDC. Follow all safety precautions, warnings and directions given in the following section when using the instrument.

1. Only technically qualified personnel should be allowed to operate the safety analyzer.
2. The operating workplace must be fully isolated, especially when the instrument is in operation. The instrument should be clearly labeled with appropriate warning signage.
3. The operator should not wear any conductive materials, jewelry, badges, or other items, such as wrist watches.
4. The operator should wear insulation gloves for high voltage protection.
5. Ensure the earth ground of the line voltage is properly grounded.
6. Ensure any devices that are adversely affected by magnetic fields are not placed near the tester.

Operating Precautions

Background The GPT-12000 is a high voltage instrument that outputs dangerous voltages. The following section describes precautions and procedures that must be followed to ensure that the tester is operated in a safe manner.



WARNING

The GPT-12000 generates voltages of up to 5kVAC or 6kVDC. Follow all safety precautions, warnings and directions given in the following section when using the instrument.

1. Never touch the safety analyzer, lead wires, terminals, probes and other connected equipment when the tester is testing.
2. Do not turn the safety analyzer on and off quickly or repeatedly. When turning the power off, please allow a few moments before turning the power back on. This will allow the protection circuits to properly initialize.

Do not turn the power off when a test is running, unless in an emergency.

3. Only use those test leads supplied with the instrument. Leads with inappropriate gauges can be dangerous to both the operator and the instrument.
For GB testing, never use the Sense leads on the SOURCE terminals.
4. Do not short the HIGH VOLTAGE terminal with ground. Doing so could charge the chassis to dangerously high voltages.

5. Ensure the earth ground of the line voltage is properly grounded.
6. Only connect the test leads to the HIGH VOLTAGE/SOURCE H/SENSE H terminals before the start of a test. Keep the test leads disconnected at all other times.
7. Always press the STOP button when pausing testing.
8. Do not leave the safety analyzer unattended. Always turn the power off when leaving the testing area.
9. When remotely controlling the safety analyzer, ensure adequate safety measures are in place to prevent:
 - Inadvertent output of the test voltage.
 - Accidental contact with the instrument during testing. Ensure that the instrument and DUT are fully isolated when the instrument is remotely controlled.
10. Ensure an adequate discharge time for the DUT.

When DCW or IR tests are performed, the DUT, test leads and probes become highly charged. The GPT-12000 has discharge circuitry to discharge the DUT after each test. The time required for a DUT to discharge depends on the DUT and test voltage.

Never disconnect the safety analyzer before a discharge is completed.

Basic Safety Checks

Background The GPT-12000 is a high voltage device and as such, daily safety checks should be made to ensure safe operation.

1. Ensure all test leads are not broken and are free from defects such as cracks or splitting.
 2. Ensure the safety analyzer is always connected to an earth ground.
 3. Test the safety analyzer operation with a low voltage/current output:
 Ensure the safety analyzer generates a FAIL judgment when the HIGH VOLTAGE and RETURN terminals are shorted (using the lowest voltage/current as the testing parameters).
-



WARNING

Do not use high voltages/currents when the HIGH VOLTAGE and RETURN terminals are shorted. It may result in damage to the instrument.

OPERATION

Menu Tree	30
Menu Tree Overview	31
Test Lead Connection	35
ACW, DCW, IR Connection	35
GB Connection	36
CONT Connection	37
Manual Tests	38
Setting the Test Function	39
Choose/Recall a Manual Test Number	40
Creating a MANU Test File Name	41
Setting the Upper and Lower Limits	42
Setting the Test Time	44
Setting the Ramp Up Time	46
Setting the Ramp Down Time	48
Setting the Test Voltage or Test Current	50
Setting the Test Frequency	52
Setting a Reference Value	53
Setting an Initial Voltage	54
Setting the Wait Time	56
Setting the ARC Function	58
Setting MAX HOLD	61
Setting PASS HOLD	62
Setting IR Mode	63
Setting GND OFFSET	65
Setting GB Contact	67
Zero Check for the Test Leads	69
Setting the Grounding Mode	72
Setting Contact Check	76
Running a MANU Test	78

PASS / FAIL MANU Test.....	83
Special MANU Test Mode (000)	88
Sweep Function.....	90
Automatic Tests	93
Choose/Recall an AUTO Test	94
Creating an AUTO Test File Name	95
Adding a Step to the AUTO Test	96
Continuous AUTO Tests	98
AUTO Test Page Editing	100
Running an Automatic Test	105
Automatic Test Results.....	111

Menu Tree Overview

MANU Mode MANU mode is used to create and/or execute a single test. Only under MANU mode can parameters be edited for each manual test.

MANU mode



AUTO Mode AUTO mode indicates that the tester is automatic, which consists of a sequential AUTO test of up to 10 MANU steps. Also, several groups of AUTO tests can be further interconnected for an advanced AUTO test.

AUTO mode

MANU STEP	TEST MODE	V/I SETTING	HI SETTING	LOW SETTING	STEP HOLD
001	DCW	0.100kV	1.000mA	000 uA	P.C/F.C
002	ACW	0.100kV	1.000mA	000 uA	P.C/F.C
026	IR	0.050kV	49.99GΩ	001.0MΩ	P.C/F.C

AUTO:001 AUTO_NAME **RES40V**
↑ ↓ ← →

SYSTEM Mode

System mode covers the Display Set, Buzzer, Interface, Control, System Time, Data Initialize, Information, Statistics, USB Disk and CONTACT CHK settings. These settings are system-wide and applied to both MANU and AUTO tests.

SYSTEM mode



READY Status (Yellow Color)

When the tester is in READY status of MANU or AUTO test, it is ready to begin testing. Pressing the START button will begin testing and put the tester into TEST status. Pressing the AUTO key will change from MANU - READY status to AUTO - READY status and vice versa.

READY status in MANU test



READY status in AUTO test

AUTO: 001	AUTO_NAME					READY	
MANU	TEST	V/I	HI	LOW	STEP		
STEP	MODE	SETTING	SETTING	SETTING	SETTING	STEP	HOLD
001	DCW	0.100kV	1.000mA	000 uA		P.C/F.H	
002	ACW	0.100kV	1.000mA	000 uA		P.H/F.C	
005	IR	0.050kV	066.8MO	000.1MO		P.C/F.S	
010	ACW	0.200kV	2.000mA	000 uA		P.C/F.C	
006	DCW	0.500kV	1.500mA	000 uA		P.H/F.S	
							SKIP
							DEL.
							STEP
							HOLD

Test Lead Connection

This section describes how to connect the GPT-12000 to a DUT for withstanding, insulation resistance, ground bond as well as continuity testing.

ACW, DCW, IR Connection

Background ACW, DCW and IR tests use the HIGH VOLTAGE terminal and RETURN terminal with the GHT-115 test leads.

ACW, DCW, IR Connection

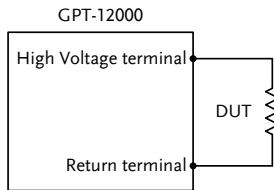

- Steps**
1. Turn the power off on the safety analyzer.
 2. Connect the high voltage test lead (red) to the HIGH VOLTAGE terminal and screw firmly into place.
 3. Connect the return test lead (white) into the RETURN terminal and screw the protector bar into place, as shown below.

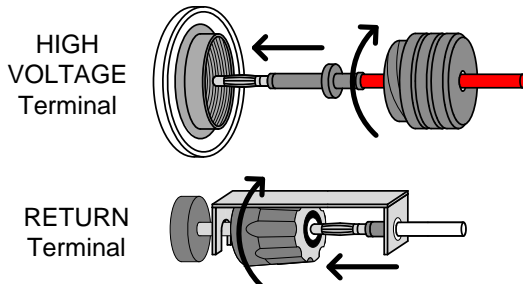

GB Connection

Background

GB tests use the SENSE H/L and SOURCE H/L terminals with the GTL-215 test leads.

GB Connection

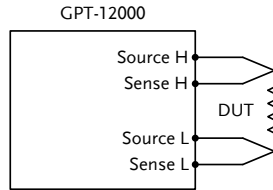

Steps

1. Turn the power off on the safety analyzer.
2. Connect the Sense H lead to the SENSE H terminal.
3. Connect the Sense L lead to the SENSE L terminal.
4. Connect the Source H lead to the SOURCE H terminal.
5. Connect the Source L lead to the SOURCE L terminal.

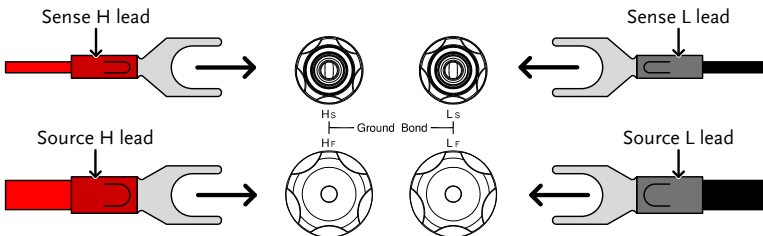

CONT Connection

Background CONT tests use the OUTPUT and RETURN terminals with the GTL-115 test leads.

CONT Connection

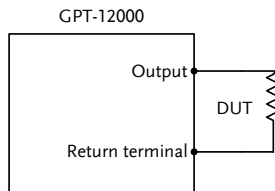

- Steps**
1. Turn the power off on the safety analyzer.
 2. Connect the OUTPUT test lead (red) to the OUTPUT terminal.
 3. Connect the RETURN test lead (black) into the RETURN terminal and screw the protector bar into place, as shown below.

OUTPUT Terminal

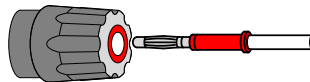

RETURN Terminal

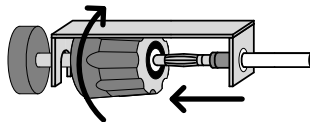

Manual Tests

This section describes how to create, edit and run a *single* ACW, DCW, IR, GB and CONT manual tests. Each Manual setting described in this chapter *only applies to the selected* manual test – *no other manual tests are affected*.

Each manual test can be stored/recalled to/from one of 100 memory locations. Each stored manual test can be used as a test step when creating an AUTO test (page 90).

- Setting the Test Function → from page 39.
- Choose/Recall a Manual Test Number → from page 40.
- Creating a MANU Test File Name → from page 41.
- Setting the Upper and Lower Limits → from page 42.
- Setting the Test Time → from page 44.
- Setting the Ramp Up Time → from page 46.
- Setting the Ramp Down Time → from page 48.
- Setting the Test Voltage or Test Current → from page 50.
- Setting the Test Frequency → from page 52.
- Setting a Reference Value → from page 53.
- Setting an Initial Voltage → from page 54.
- Setting the Wait Time → from page 56.
- Setting the ARC Function → from page 58.
- Setting MAX HOLD → from page 61.
- Setting PASS HOLD → from page 62.
- Setting IR Mode → from page 63.
- Setting GND OFFSET → from page 65.
- Setting GB Contact → from page 67.
- Zero Check for the Test Leads → from page 69.
- Setting the Grounding Mode → from page 72.
- Setting Contact Check → from page 76.
- Running a MANU Test → from page 78.
- PASS / FAIL MANU Test → from page 83.
- Special MANU Test Mode (000) → from page 88.
- Sweep Function → from page 90.

Setting the Test Function

Background There are five test functions, AC Withstand, DC Withstand, Insulation Resistance, Ground Bond and Continuity tests.

- Steps**
1. If the tester is in AUTO or SYSTEM mode, press the MANUAL key to put the tester into MANU mode. 
 2. To choose the test function, press the ACW, DCW, IR, GB or CONT key on the front panel.



3. The key of selected test function is lit, and the test function selected is shown on the upper-left corner of the display.

Selected Test Function



Choose/Recall a Manual Test Number

Background ACW, DCW, IR, GB and CONT tests can only be created and edited in the MANU mode. MANU number 001 to 100 can be saved and thus be loaded when editing/creating a MANU test or AUTO test. MANU number 000 is a special mode. See page 88 for details on the special mode.

- Steps**
1. If the tester is in AUTO or SYSTEM mode, simply press the **MANUAL** key to switch to MANU mode.
 2. Use the scroll wheel to choose the MANU number.
- MANU # 001~100
(MANU# 000 is a special mode)

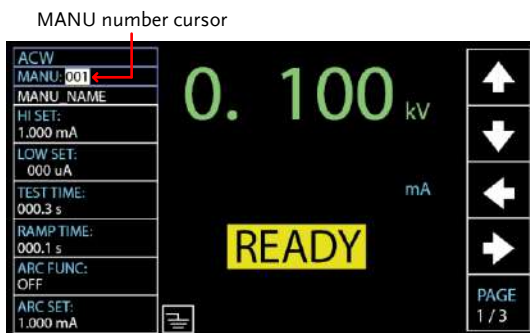

 **Note**

Manual number can only be selected or recalled when the “READY” status shows on the screen. If the “FAIL” status appears, it is required to press STOP key first before selecting or recalling procedure.

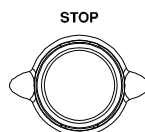

Creating a MANU Test File Name

Background Each manual test can have a user-defined name (default: MANU_NAME) up to 10 characters long. See the available list of characters below.

Character List

0	1	2	3	4	5	6	7	8	9	_
A	B	C	D	E	F	G	H	I	J	K
L	M	N	O	P	Q	R	S	T	U	V
W	X	Y	Z	a	b	c	d	e	f	g
h	i	j	k	l	m	n	o	p	q	r
s	t	u	v	w	x	y	z			

Steps

1. Press the UP / DOWN arrow soft-keys to bring the cursor to the MANU_NAME (default name) field. The characters table will appear in the right hand accordingly.

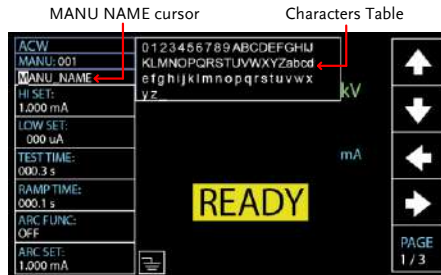

2. Use the scroll wheel to scroll through the available characters.
3. Press the LEFT / RIGHT arrow soft-keys to move the cursor to the next character.
4. The MANU test file name is set when the cursor is moved to another setting.



Setting the Upper and Lower Limits

Background There is both a LOW and HI judgment setting. When the measured value is below the LOW SET setting, the test will be judged as FAIL. When the value exceeds the HI SET setting the test will be judged as FAIL. Any measurement between the LOW SET and HI SET setting is judged as PASS. The LOW SET limit cannot be made greater than the HI SET limit.

- Steps**
1. Press the UP / DOWN arrow soft-keys to bring the cursor to the HI SET setting. 

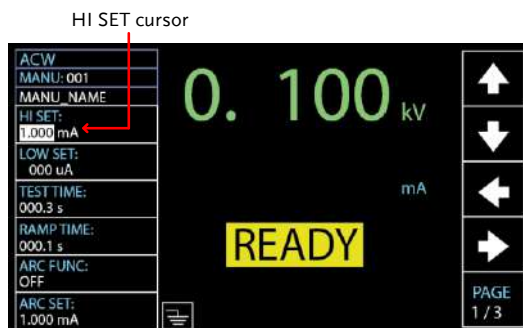

2. Use the scroll wheel to set the HI SET limit. 

ACW (HI)	001uA~42.00mA
DCW (HI)	001uA~11.00mA
IR (HI)	000.2MΩ~50.00GΩ, OFF
GB (HI)	000.1mΩ~650.0mΩ
CONT (HI)	00.01Ω~80.00Ω

3. Press the UP / DOWN arrow soft-keys to bring the cursor to the LOW SET setting.

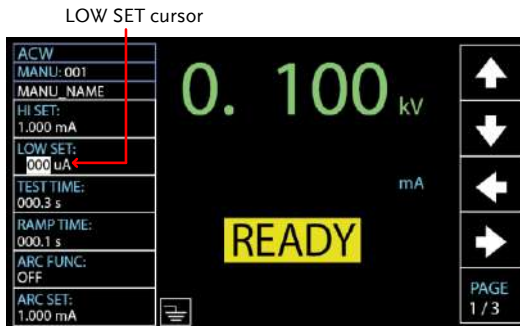

4. Use the scroll wheel to set the LOW SET limit.



ACW (LOW)	000uA~41.99mA
DCW (LOW)	000uA~10.99mA
IR (LOW)	000.1MΩ~49.99GΩ
GB (LOW)	000.0mΩ~649.9mΩ
CONT (LOW)	00.00Ω~79.99Ω



Note

*Please note that the resolution of the measured value depends on the resolution of HI SET setting.



Note

The LOW SET setting is limited by the HI SET setting. The LOW SET limit cannot be greater than the HI SET limit.

When setting the current, be aware that a maximum of 200VA can be set for ACW and 50W for DCW, respectively.

Setting the Test Time

Background

This setting is used to set the test time for a test. The test time determines how long the test voltage or current is applied to the DUT. This test time does not include RAMP UP time or RAMP DOWN time (note: GB and CONT do not have RAMP UP or RAMP DOWN). The test time can be set from 0.3 seconds to 999.9 seconds for ACW, DCW, IR, GB and CONT, with a resolution of 0.1 seconds for all modes. Also, the test time can be turned off when using the ACW or DCW test functions.

Each test has a RAMP UP and RAMP DOWN time (except GB and CONT), respectively. Refer to page 46 & 48 for more details.

Output Voltage Timing Chart (Resistive load)

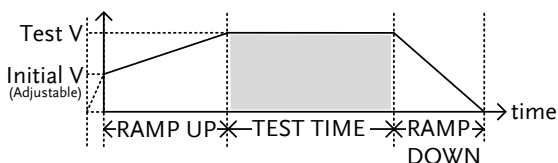

Steps

1. Press the UP / DOWN arrow soft-keys to bring the cursor to the TEST TIME setting.

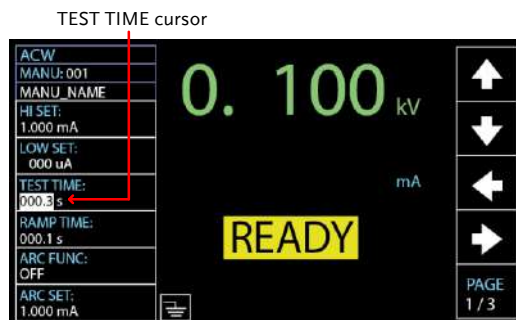

- Use the scroll wheel to set the TEST TIMER value.



ACW	OFF, 000.3s~999.9s
DCW	OFF, 000.3s~999.9s
IR	000.3s~999.9s
GB	000.3s~999.9s
CONT	000.3s~999.9s



Note

With the ACW test function, when the test current is beyond 30mA, the Ramp Up Time + Test Time cannot exceed 240 seconds. At this current level, the tester also needs to pause after a test for a time equal to or greater than the output time.

Turn Off Test Time

When in either ACW or DCW test, the TEST TIME can be turned off, which means the test without test time will last infinitely until FAIL judgment occurs.

Identical with the regular setting for TEST TIME, turn off the timer by using the scroll wheel to set OFF for TEST TIME value.



TEST TIME OFF



Setting the Ramp Up Time

Background

The Ramp Up time is the total time taken for the tester to reach the test voltage level. The Ramp Up time starts with a start voltage of 50 volts. The Ramp Up time can be set from 000.1 to 999.9 seconds. The Ramp Up time is only applicable for ACW, DCW and IR tests.

Output Voltage Timing Chart (Resistive load)

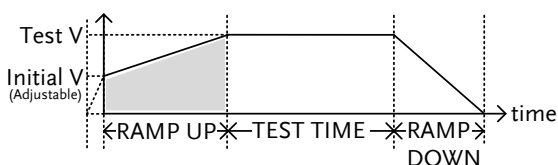

Steps

1. Press the UP / DOWN arrow soft-keys to bring the cursor to the RAMP TIME setting.



RAMP TIME cursor



2. Use the scroll wheel to set the RAMP TIME value.



ACW	000.1s~999.9s
DCW	000.1s~999.9s
IR	000.1s~999.9s

Ramp Time
Duration
Indicator

After pressing START to begin a test with set RAMP TIME, a section at the lower right corner of display shows the counting duration of RAMP TIME, which will run to the set value followed by the test time. See the screenshot shown below.

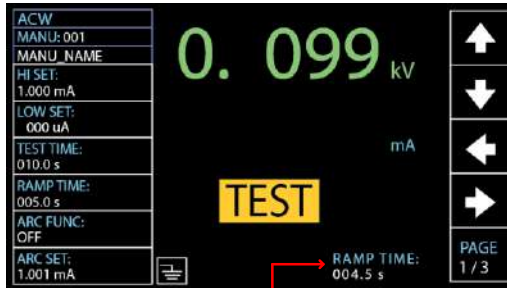

RAMP TIME duration indicator

Setting the Ramp Down Time

Background

The Ramp Down time is the time taken for the DUT to discharge the test voltage level. The Ramp Down time can be set from 000.0 to 999.9 seconds. The Ramp DOWN time is only applicable for ACW, DCW and IR tests.

Output Voltage Timing Chart (Resistive load)

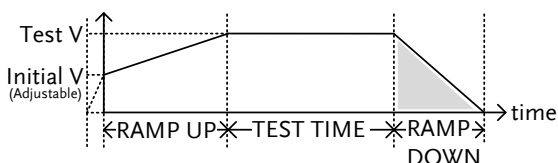

Steps

1. Press the PAGE soft-key to move to the 2/3 page where RAMP DOWN setting appears for ACW and DCW.



As for IR test, the RAMP DOWN setting shows in the 2/2 page.



2. Press the UP / DOWN arrow soft-keys to bring the cursor to the RAMP DOWN setting.



RAMP DOWN cursor



- Use the scroll wheel to set the RAMP DOWN value.



ACW 000.0s~999.9s
 DCW 000.0s~999.9s
 IR 000.0s~999.9s

Ramp Down
 Duration
 Indicator

After the set TEST TIME is fully completed, a section at the lower right corner of display shows the counting duration of RAMP DOWN, which will run to the set value by user. See the screenshot shown below.

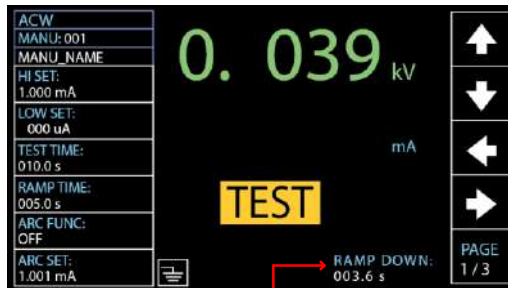



RAMP DOWN duration indicator

Setting the Test Voltage or Test Current

Background The test voltage can be set from 0.050kV to 5.1kV for ACW, 0.050kV to 6.1kV for DCW and 0.050 to 1.2kV for IR (50V steps*). For GB tests the test current can be set from 3A to 33A. As for CONT test, the test current is fixedly set at the default value of 100mA.

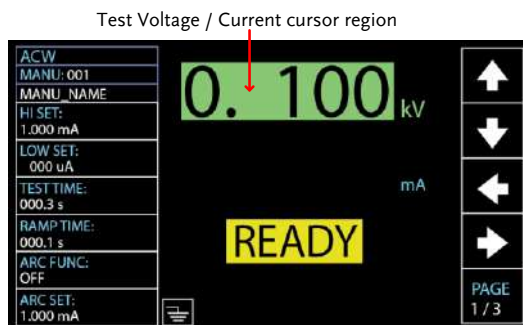
- Steps**
1. Press the UP / DOWN arrow soft-keys to bring the cursor to the voltage or ampere setting depending on selected test function. 



2. Use the scroll wheel to set the test voltage or ampere level. 

ACW	0.050kV ~ 5.1kV ¹
DCW	0.050kV ~ 6.1kV ²
IR	0.05kV ~ 1.2kV (50V steps)
GB	3.00A ~ 33.00A
CONT	100mA ³

¹ At least 0.3 seconds is needed to reach a set voltage of 50V/10mA.

² At least 0.3 seconds is needed to reach a set voltage of 50V/2mA.

³ Test current for CONT is fixed at 100mA



Note

When setting the current, be aware that a maximum of 200VA can be set for ACW and 50W for DCW, respectively.

The ground bond voltage (GBV) is calculated as the HI SET limit x Test Current.



Setting the Test Frequency

Background A test frequency of 60Hz or 50Hz can be set, regardless of the input line voltage. The test frequency setting only applies to ACW and GB tests.

 **Note** The test frequency can only be set for ACW or GB tests.

Steps 1. Press the PAGE soft-key to move to the 2/3 page where FREQ setting appears for ACW. 

As for GB test, the FREQ setting shows in the 1/2 page directly. 

2. Press the UP / DOWN arrow soft-keys to bring the cursor to the FREQ setting.  

FREQ setting cursor



3. Use the scroll wheel to set the test frequency. 

ACW, GB 50Hz, 60Hz

Setting a Reference Value

Background The REF VALUE acts as an offset. The REF VALUE is subtracted from the measured current (ACW, DCW) or measured resistance (IR, GB, CONT).

Steps

1. Press the PAGE soft-key to move to the 3/3 page where REF VALUE setting appears for ACW and DCW. 

As for IR and GB, the REF VALUE setting shows in the 2/2 page. 

The REF VALUE setting appears in the 1/1 page directly for CONT. 

2. Press the UP / DOWN arrow soft-keys to bring the cursor to the REF VALUE setting. 

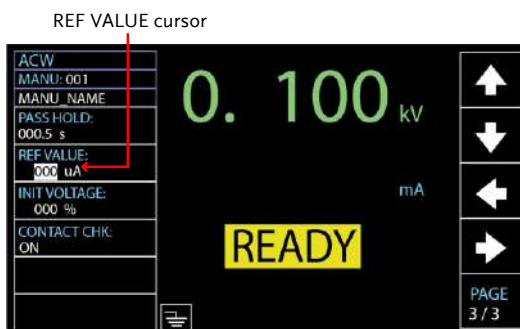

3. Use the scroll wheel to set the REF value. 

ACW	000 μ A~HI SET current-0.1mA *HI SET + REF value \leq 42.00 mA
DCW	000 μ A~HI SET current-0.1mA *HI SET + REF value \leq 11.00 mA
IR	000.0M Ω ~50.00G Ω
GB	000.0m Ω ~650.0m Ω *ISET x (HI SET + REF value) is no greater than 7.2V
CONT	00.00 Ω ~80.00 Ω *ISET(100mA) x (HI SET + REF value) is no greater than 8V



Note

For IR test, a reference value of tester can be automatically created via the GND OFFSET function. See page 65 for details.

For GB and CONT tests, a reference value of test lead can be automatically created via the ZERO CHECK function. See page 69 for details.

Setting an Initial Voltage

Background

In essence, the test voltage for both ACW and DCW will gradually and linearly rise up, from zero, to the target set voltage in accord with the set RAMP TIME ahead of the TEST TIME.

Nevertheless, under certain circumstances, user may have preferences on the percentage of starting test voltage. Therefore, the INIT VOLTAGE provides another alternative for different applications on user side.

It is easy to set a preferred percentage of the test voltage in the INIT VOLTAGE setting and the starting test voltage will commence from

the value corresponding to the set percentage relative to the target test voltage.



Note

INIT VOLTAGE setting is only applicable to both ACW and DCW tests.

Steps

1. Press the PAGE soft-key to move to the 3/3 page where the INIT VOLTAGE setting appears for ACW and DCW.



2. Press the UP / DOWN arrow soft-keys to bring the cursor to the INIT VOLTAGE setting.



INIT VOLTAGE cursor

3. Use the scroll wheel to set the percentage of INIT VOLTAGE.



INIT VOLTAGE 000% ~ 099%

Setting the Wait Time

Background

The Wait Time refers to the pending time before FAIL judgment appears. By default, FAIL judgment appears when Test Time has reached 0.3 second at the earliest manner. However, when user sets 1.0 second for Wait Time on the tester with 0.5 second of Ramp Up time and 1.0 second of Test Time, the FAIL judgment will be shown when Test Time has reached 0.5 second. In short, Wait Time is the pending duration which dominates the priority over both Ramp UP time and Test Time in terms of timing of FAIL judgment.

The WAIT TIME is only applicable for ACW, DCW and IR tests.

Steps

1. Press the PAGE soft-key to move to the 2/3 page where WAIT TIME setting appears for ACW and DCW.



As for IR test, the WAIT TIME setting shows in the 1/2 page.



2. Press the UP / DOWN arrow soft-keys to bring the cursor to the WAIT TIME setting.



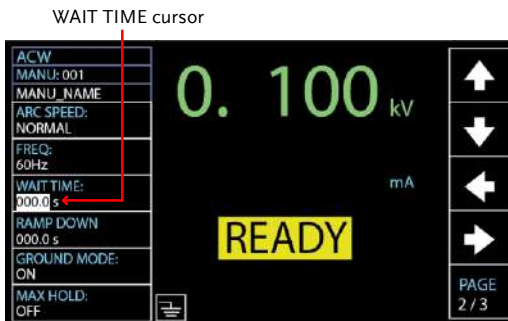

- Use the scroll wheel to set the WAIT TIME value.



ACW	000.0s~999.9s
DCW	000.0s~999.9s
IR	000.0s~999.9s

Wait Time Indicator

While the WAIT TIME is set, the indicator of WAIT TIME will be shown on the display in the set duration during a test progress for clear identification for user.



WAIT TIME indicator

Setting the ARC Function

Background

ARC detection, otherwise known as flashover detection, detects fast voltage or current transients that are not normally detected. Arcing is usually an indicator of poor withstanding insulation, electrode gaps or other insulating problems that cause temporary spikes in current or voltage during ACW and DCW testing.

There are three ARC detection settings: OFF, ON & CONT, ON & STOP.

The ON & CONT setting will detect arcs over the ARC current level and continue the test, the ON & STOP setting will stop the test when an arc is detected.

ARC mode settings only apply to both ACW and DCW tests.

Steps

1. Press the UP / DOWN arrow soft-keys to bring the cursor to the ARC FUNC setting.

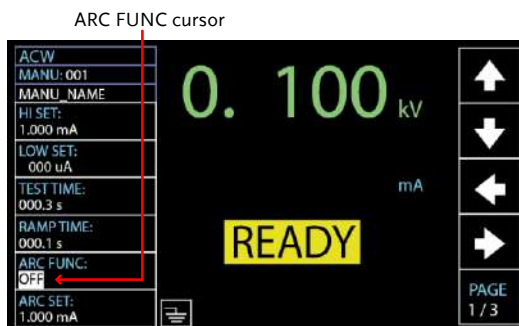

2. Use the scroll wheel to set the ARC modes setting.



ARC MODES: OFF
 ON & CONT
 ON & STOP

- If the ARC MODE was set to either ON & CONT, or ON & STOP, the ARC current level can be edited. Press the DOWN arrow soft-key to bring the cursor to the ARC SET setting field.

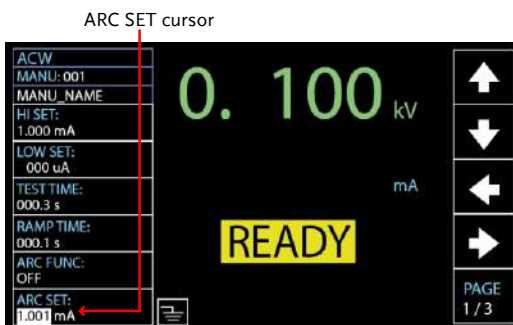

- Use the scroll wheel to edit the ARC SET level.



ACW	1.000mA~80.00mA
DCW	1.000mA~20.00mA

- If the ARC MODE was set to either ON & CONT, or ON & STOP, the ARC speed, which indicates the threshold for width of detected ARC, can be edited. Press the PAGE soft-key to move to the 2/3 page where ARC SPEED setting appears for ACW and DCW.



- Press the UP / DOWN arrow soft-keys to bring the cursor to the ARC SPEED setting field.

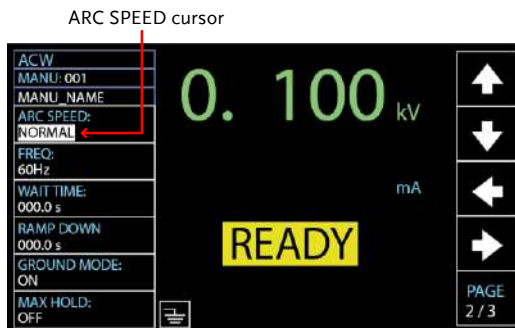

- Use the scroll wheel to select the ARC SPEED modes.



ARC SPEED	FAST	Threshold for the narrowest width of detected arc, which is the most sensitive manner.
	NORMAL	Threshold for the general width of detected arc.
	SLOW	Threshold for the widest width of detected arc, which is the manner of high tolerance.

Setting MAX HOLD

Background

The MAX HOLD setting will hold the maximum current measured in the ACW and DCW tests or the maximum resistance measured in the IR and GB tests.

For instance, when running an IR test with 120 seconds of test time and MAX HOLD enabled, the highest resistance measured in the 30 seconds of the test time will be retained on display until the next largest value. If there is no further maximum resistance occurred, the value measured in 30 seconds will be remained till the end of the test of 120 seconds.

Steps

1. Press the PAGE soft-key to move to the 2/3 page where MAX HOLD setting appears for ACW and DCW.



As for IR and GB, the MAX HOLD setting shows in the 2/2 page.



2. Press the UP / DOWN arrow soft-keys to bring the cursor to the MAX HOLD setting.

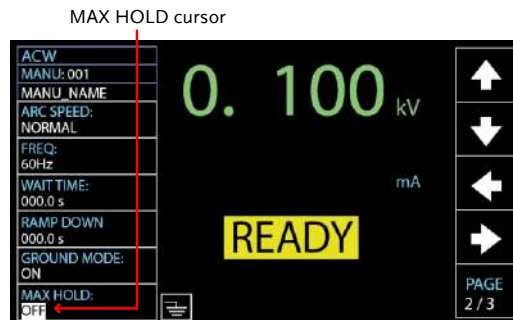

3. Use the scroll wheel to set MAX HOLD.



MAX HOLD OFF, ON

Setting PASS HOLD

Background	The PASS HOLD setting refers to the holding duration after PASS judgment is shown on the display. When the PASS HOLD setting is set, a PASS judgment is held until the set duration is fully reached.
------------	---



Note

The PASS HOLD setting only applies to MANU tests. This setting is ignored when running AUTO test.

Steps

1. Press the PAGE soft-key to move to the 3/3 page where PASS HOLD setting appears for ACW.



And it is the 2/3 page where PASS HOLD setting appears for DCW.



As for IR and GB, the PASS HOLD setting shows in the 2/2 page.



The PASS HOLD setting appears in the 1/1 page directly for CONT.



2. Press the UP / DOWN arrow soft-keys to bring the cursor to the PASS HOLD setting.



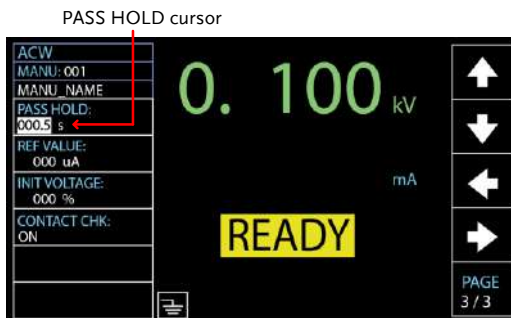

- Use the scroll wheel to set PASS HOLD duration.



PASS HOLD 000.0s ~ 999.9s, ON



Note

- The STOP key can be pressed at any time in the set duration of PASS HOLD to promptly halt the set PASS HOLD duration. In short, user can stop, if necessary, the duration of PASS HOLD any time.
- When ON is selected, the duration of PASS HOLD will remain indefinitely until the STOP key is further pressed.

Setting IR Mode

Background

The IR MODE setting, which contains three options, STOP ON FAIL, STOP ON PASS, TIMER, only applies to IR test.

When IR MODE is set to STOP ON FAIL, the tester will show the FAIL judgment, if available, in the 0.3 second of test time at the earliest manner, regardless of the set test time.

When set to PASS ON FAIL, the tester will show the PASS judgment, if available, in the 0.3

second of test time at the earliest manner, regardless of the set test time.

The TIMER mode will run a test in a full course completely in accordance with the set test time, whether the final judgment is PASS or FAIL.



Note

If the DUT is under the situation of abnormal measurement, e.g., short circuit, the FAIL judgment of SHORT warning, though TIMER is set, will appear in the early manner regardless of the set test time.

Steps

1. Press the PAGE soft-key to move to the 2/2 page where IR MODE setting appears for IR test.



2. Press the UP / DOWN arrow soft-keys to bring the cursor to the IR MODE setting.



IR MODE cursor

3. Use the scroll wheel to set the IR MODE.





IR MODE STOP ON FAIL
 STOP ON PASS
 TIMER

Setting GND OFFSET

Background The GND OFFSET is used to determine the offset resistance of the tester. When a GND OFFSET is performed, the reference is automatically set to the measured resistance.

 **Note** GND OFFSET setting is only applicable to IR test.

- Steps**
1. Press the PAGE soft-key to move to the 2/2 page where GND OFFSET setting appears for IR testing. 
 2. Press the UP / DOWN arrow soft-keys to bring the cursor to the GND OFFSET setting. When selecting ON, the ZERO CHECK indicator will be shown on the display. 



GND OFFSET cursor ZERO CHECK indicator

3. Press the START button to perform the GND OFFSET. The resistance of the tester, after the GND OFFSET has finished, will be added into the REF VALUE field as the display shown below.

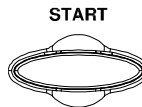

Resistance of the tester

Setting GB Contact

Background Basically, GB test has no ramp up time and thus starts from the set test time by user directly. However, due to some cases where a buffer time before test time is in fact required for GB test, e.g., in conveyor where DUTs are tested for GB by batches and certain buffer duration needed for test leads or jigs connecting with DUTs, the GB CONTACT setting practically allows user to apply to customized scenarios when necessary occurs.



Note

GB CONTACT setting is only applicable to GB test.

Steps

1. Press the UP / DOWN arrow soft-keys to bring the cursor to the GB CONTACT setting.

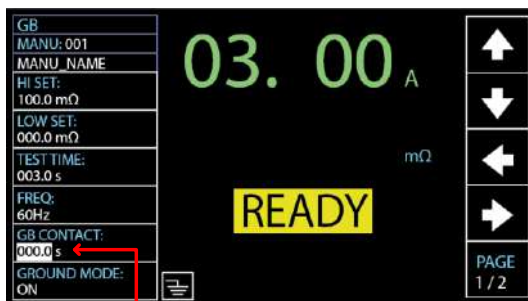

GB CONTACT cursor

2. Use the scroll wheel to set the value of GB CONTACT



GB CONTACT 000.0 s ~ 999.9 s

GB CONTACT
Duration
Indicator

After every parameter including GB CONTACT is well set, press START to begin the GB test. A section at the lower right corner of display shows the counting duration of GB CONTACT, which will run to the set value followed by the test time. See the screenshot shown below.



GB CONTACT duration indicator

Zero Check for the Test Leads

Background The Zeroing function is used to determine the resistance of the test leads for GB and CONT tests. When a ZERO CHECK is performed, the reference is automatically set to the measured resistance of the test leads.



Note

ZERO CHECK setting is only applicable to both GB and CONT tests.

Steps

1. Short the positive and negative alligator clips as shown below.

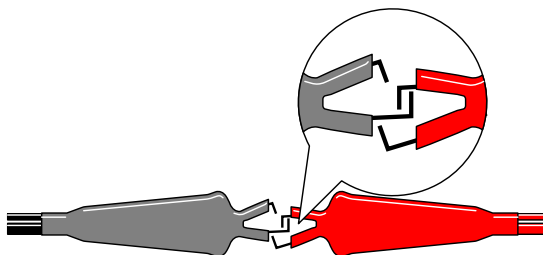

2. Press the PAGE soft-key to move to the 2/2 page where ZERO CHECK setting appears for GB testing.

PAGE
2 / 2

As for CONT, ZERO CHECK setting shows in the 1/1 page directly.

PAGE
1 / 1

3. Press the UP / DOWN arrow soft-keys to bring the cursor to the ZERO CHECK setting. When selecting ON, the ZERO CHECK indicator will be shown on the display.



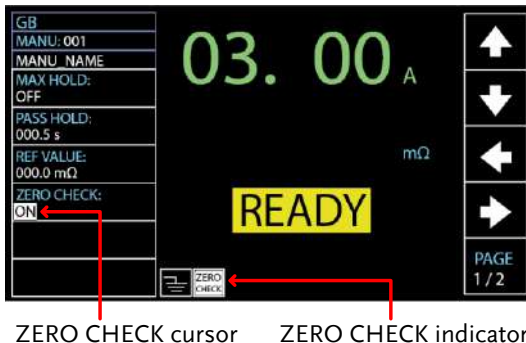

4. Press the START button to perform the zero check. The resistance of the test leads, after the ZERO CHECK has finished, will be added into the REF VALUE field as the display shown below.

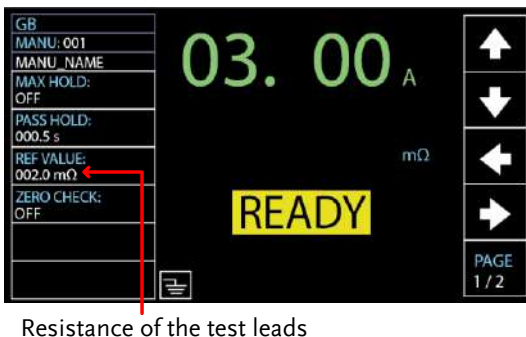
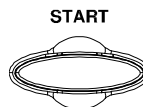

 Note

Remember to replace the test leads to the proper position on the DUT before testing.

FAIL – GBI LOW

If SOURCE H/L terminals are open or poorly connected, the FAIL – GBI LOW status will appear on the screen. Please re-check the connection of SOURCE H/L terminals again.

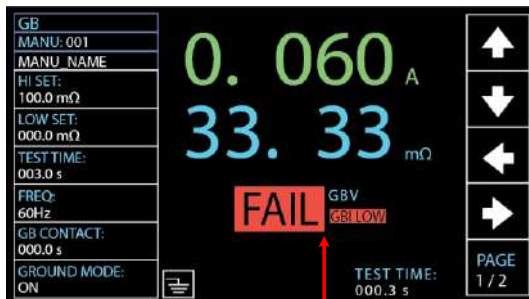

FAIL – GBI LOW status

REF VALUE = 0

Press STOP button to exit and the resistance of test leads were not properly added into the REF VALUE, which shows 000.0 mΩ as shown below. Re-check the connection of SOURCE H/L terminals and press START button again to proceed to the ZERO CHECK procedure.

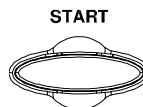

REF VALUE = 0

Setting the Grounding Mode

Background

When GROUND MODE is set to ON, the GPT-12000 grounds the return terminal to the ground. This mode is best for DUTs that are grounded to an earth ground by their chassis, fixtures or operation environment. This mode measures the potential of the HIGH VOLTAGE terminal with respect to earth ground. This means that any stray capacitance/resistance that leaks to earth ground will also be measured. This is the safest testing mode, though potentially not as accurate.

When GROUND MODE is set to OFF, the return terminal is floating with respect to the earth ground. This mode is for DUTs that are floating and not directly connected to an earth ground. This is more accurate than when GROUND MODE is set to ON as any stray capacitance/resistance that leaks to the earth ground from the DUT side of the testing circuit will not be measured. For this reason, this testing mode is able to measure to a higher resolution.

GROUND MODE = ON, DUT grounded

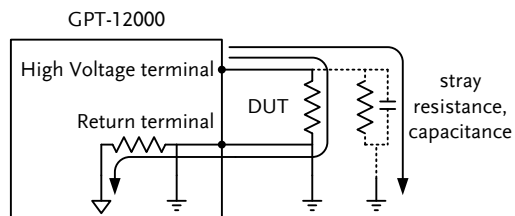

GROUND MODE = ON, DUT floating

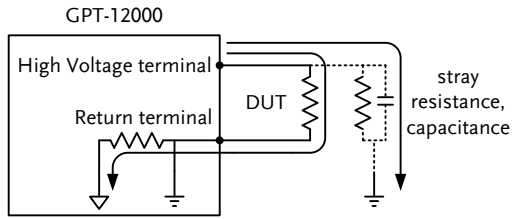

GROUND MODE = OFF, DUT floating

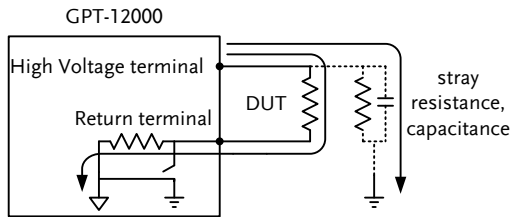

GPT-12000 (GB testing)

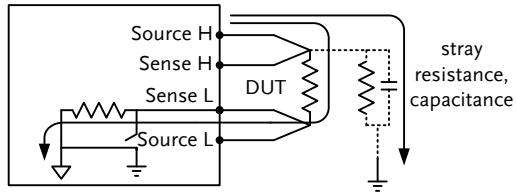

GROUND MODE = OFF, DUT grounded

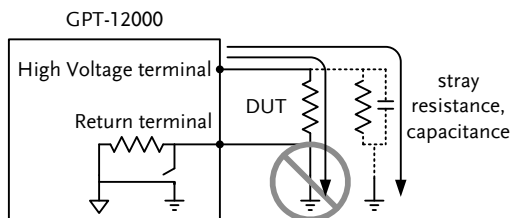

GPT-12000 (GB testing)

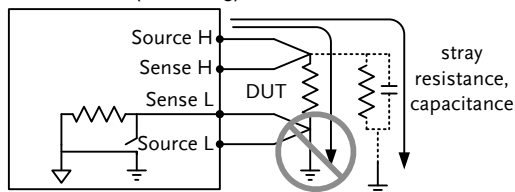

Warning

When GROUND MODE is set to OFF, the DUT, fixtures or connected instrumentation cannot be grounded. This will short circuit the internal circuitry during a test.

For ACW and DCW tests, if it is not known whether the DUT test setup is grounded or not, always set GROUND MODE to ON.

Only set GROUND MODE to OFF when the DUT is floating electrically.

Steps

1. Press the PAGE soft-key to move to the 2/3 page where GROUND MODE setting appears for ACW and DCW.

PAGE
2 / 3

As for IR and GB, the GROUND MODE setting shows in the 1/2 page.

PAGE
1 / 2

2. Press the UP / DOWN arrow soft-keys to bring the cursor to the GROUND MODE setting.



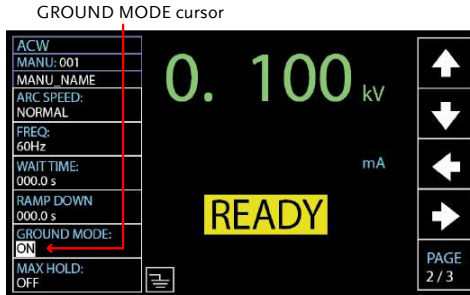

3. Use the scroll wheel to set the GROUND MODE.



GROUND MODE OFF, ON

4. The GROUND MODE icon on the display changes accordingly.

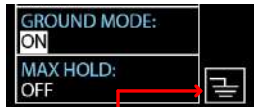

GROUND MODE ON

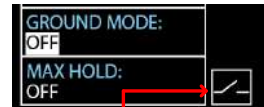

GROUND MODE OFF



Note

Under the IR test mode, when GROUND MODE is ON but test time is set $t < 0.5s$, the error message “TEST TIMR<0.5s” will be shown, by which user is not able to start the IR test mode unless the test time is reset to $> 0.5s$. Refer to page 44 for how to set the test time manually.



GROUND MODE ON

Error Message Prompts



Setting Contact Check

Background The CONTACT CHK function is used to determine if open circuit or short circuit occurs between the test leads and DUT under the ACW, DCW and IR tests. Before activating this function, it is first required to define a reference value along with relevant thresholds, for which refer to page 153.



Note

CONTACT CHK setting is only applicable to ACW, DCW and IR test modes.

- Steps**
1. After well setting up the test leads connection with DUT, refer to page 153 for how to define a reference value and relevant thresholds firstly.
 2. Press the PAGE soft-key to move to the 3/3 page where CONTACT CHK setting appears for ACW, DCW and IR tests. 
 3. Press the UP / DOWN arrow soft-keys to bring the cursor to the CONTACT CHK and turn it ON. 



CONTACT CHK ON

- After pressing the START button, the GPT-10000 unit will perform the CONTACT CHK before running a MANU test. If the measured current is lower than the reference value by user-defined percentage, the "OPEN" status appears on the screen. While the measured current is higher than the reference value by user-defined percentage, the "SHORT" status appears instead.

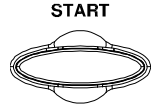

OPEN Status



OPEN Status detected

SHORT Status



SHORT Status detected

Running a MANU Test

Background A test can be run when the tester is in READY status.



Note

The tester cannot start to run a test under the following conditions:

- A protection setting has been tripped; when a protection setting has been tripped the corresponding error message is displayed on the screen. See page 233 for a comprehensive list of the all the setting errors.
 - The INTERLOCK function is ON and the Interlock key is not inserted in the signal I/O port (page 124).
 - The STOP signal has been received remotely.
 - If Double Action is ON, ensure the START button is pressed immediately after the STOP button (<0.5s).
-



Note

When a test is running the voltage output cannot be changed, unless the test is under the special manual mode. See page 88 for details.

Steps 1. Ensure the tester is in READY status for the test to come. Page 32

READY status



2. Press the START button when the tester is in the READY status. The manual test starts accordingly and the tester goes into the TEST status.

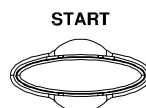

TEST status



3. The test will start by showing the ongoing ramp up time followed by the ongoing test time and the ongoing ramp down time. The test will continue until the test is finished or stopped.

RAMP UP TIME

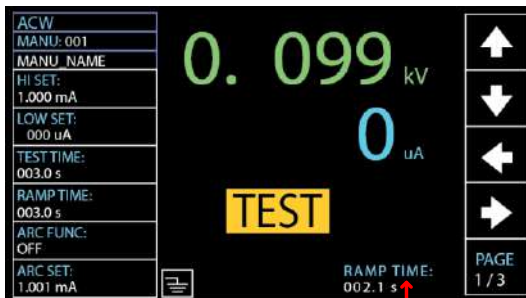

Ongoing RAMP UP TIME

TEST TIME



Ongoing TEST TIME

RAMP DOWN TIME

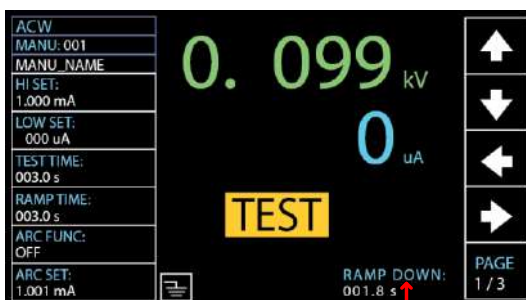

Ongoing RAMP DOWN TIME

 Note

RAMP DOWN time only appears when user has activated it. See page 48 for details.

ACW Example

Test Voltage Measured Current

ACW
MANU: 001
MANU_NAME
HI SET: 1.000 mA
LOW SET: 000 uA
TEST TIME: 003.0 s
RAMP TIME: 003.0 s
ARC FUNC: OFF
ARC SET: 1.001 mA

0. 099 kV

271 uA

TEST

TEST TIME:
002.0 s

PAGE
1 / 3

DCW Example

Test Voltage Measured Current

DCW
MANU: 001
MANU_NAME
HI SET: 1.000 mA
LOW SET: 000 uA
TEST TIME: 003.0 s
RAMP TIME: 003.0 s
ARC FUNC: OFF
ARC SET: 1.001 mA

0. 099 kV

361.6 uA

TEST

TEST TIME:
001.9 s

PAGE
1 / 3

IR Example

Test Voltage Measured Resistance

IR
MANU: 001
MANU_NAME
HI SET: 10.00 GΩ
LOW SET: 001.0 MΩ
TEST TIME: 003.0 s
RAMP TIME: 003.0 s
WAIT TIME: 000.0 s
GROUND MODE: ON

0. 097 kV

5. 536 GΩ

TEST

TEST TIME:
002.0 s

PAGE
1 / 2

GB Example

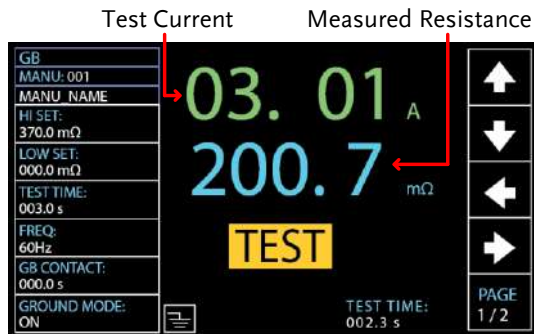

CONT Example

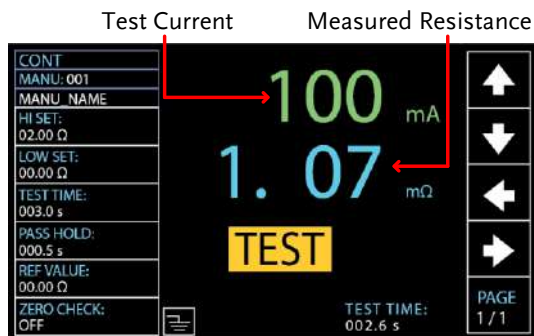

Stop the Test

1. To stop the test at any time when it is running, press the STOP button. The test will stop immediately. When the STOP button is pressed, a judgment is not made and the tester will restore to READY status.

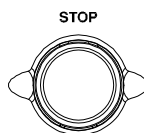

 Note

Do not touch any terminals, test leads or any other connections when the test is on.

PASS / FAIL MANU Test

Background

If the test is allowed to run to completion (the test is not stopped or a protection setting is not tripped) then the tester will judge the test as either PASS or FAIL.



Note

The test will be judged PASS when:

- The HI SET and LO SET limits have not been tripped during the test time.

The test will be judged FAIL when:

- Either the HI SET or LO SET limit has been tripped during the test time.
- A protection setting has been tripped during the test time. See page 233 for a list of error messages.

PASS Judgment

1. When the test is judged as PASS, PASS will be displayed on screen, the buzzer will sound and the PASS indicator will be lit green.

PASS



PASS Judgment



- The tester will immediately restore back to the READY status after PASS judgment. However, if the PASS HOLD is activated, PASS judgment will persist until the set duration of PASS HOLD is fully met. Refer to page 62 for details.

In addition, pressing the STOP button during the set duration of PASS HOLD can return to READY status immediately.

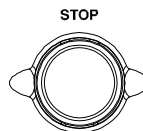

Note

The START button is disabled when the buzzer is beeping.

PASS Timing Diagrams

The timing diagrams below show the ACW, DCW, IR, GB and CONT timing for the START status, TEST status and PASS judgment.

ACW PASS Timing

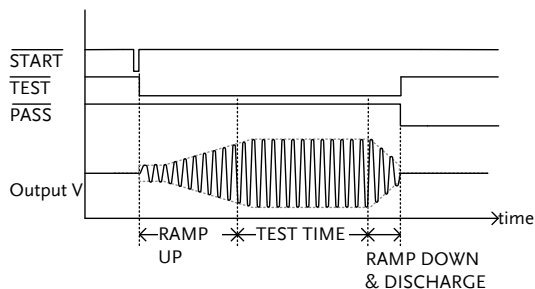

DCW PASS Timing

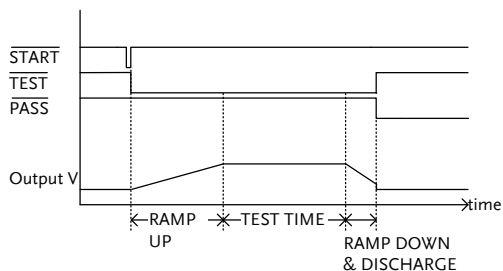

IR PASS Timing

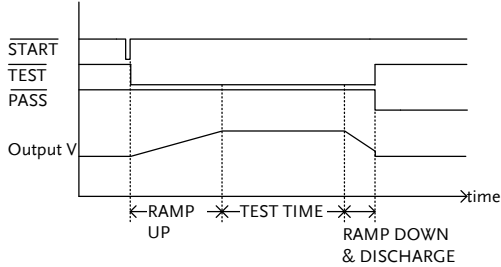

GB PASS Timing

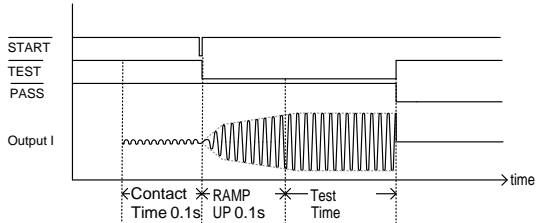

CONT PASS Timing

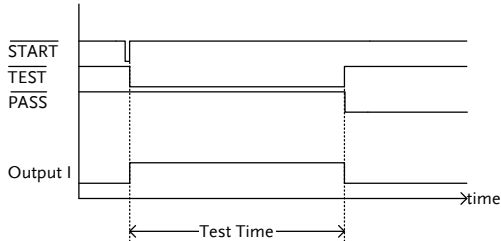

FAIL Judgment

1. When the test is judged as FAIL, FAIL will be displayed on screen, the buzzer will sound and the FAIL indicator will be lit red.

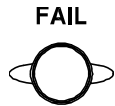

As soon as a test is judged FAIL, power is cut from the terminals.

FAIL Judgment

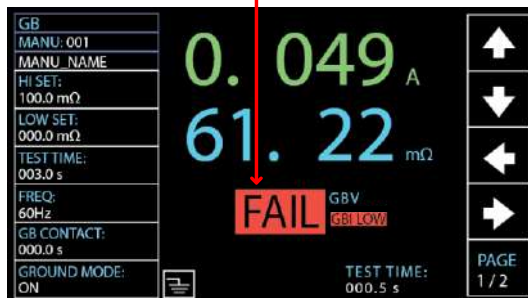

- The FAIL judgment will be held on the display until the STOP button is pressed. Pressing the STOP button will return the tester back to the READY status.

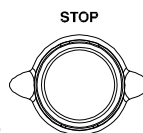

FAIL Timing Diagrams

The timing diagrams below show the ACW, DCW, IR, GB and CONT timing for the START status, TEST status and FAIL judgment.

ACW FAIL Timing

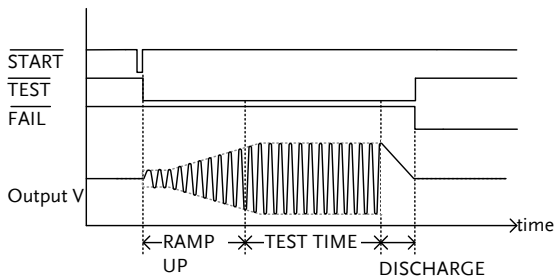

DCW FAIL Timing

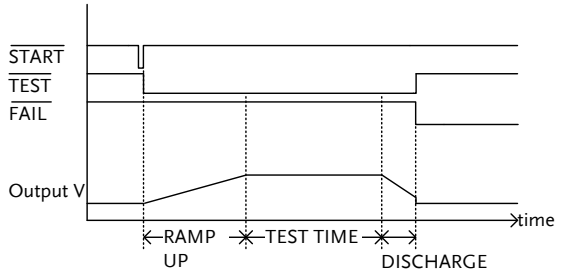

IR FAIL Timing

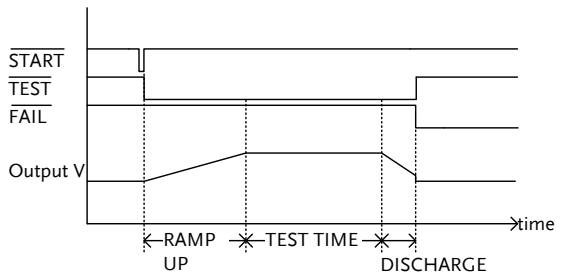

GB FAIL Timing

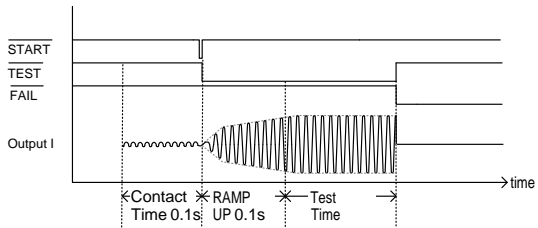

CONT FAIL Timing

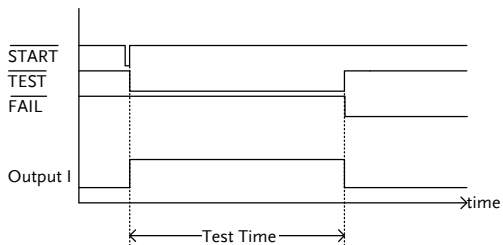

Special MANU Test Mode (000)

Special Test Mode Overview

When MANU number 000 is selected, the special test mode is activated. Under the special test mode, the voltage can be changed during a test in real time (ACW, DCW only). The test function can also be changed when in READY status, unlike under normal operation.

Separate settings can be saved under the special test mode for each of the testing functions: ACW, DCW, IR, GB and CONT. This means different test setups for ACW, DCW, IR, GB and CONT can be saved within the MANU number 000 concurrently.

Steps

1. Choose MANU number 000 to enter the special test mode. Page 40

2. The settings of a previous test can be loaded by pressing the corresponding soft-keys on the front panel.

For example, if you are currently in DCW mode, pressing the ACW key will load the ACW settings that were previously stored in the special manual mode.



3. Set all the necessary parameters for a test and save. Pages 41 ~ 72

Note: A different test setup can be saved for each test function (ACW, DCW, IR, GB and CONT). Below is an example of ACW function in special manual mode.

Special MANU Number 000

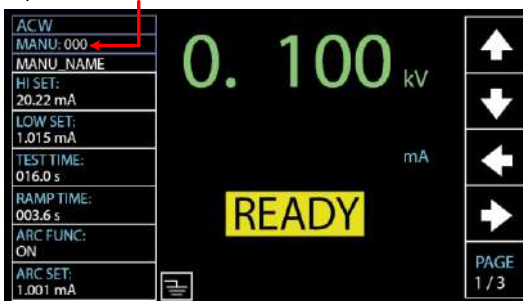

Running the Test

1. In special test mode (000), tests are started and stopped in the same way as for the normal manual test mode. See page 76 for details.
2. If required, the scroll wheel can be used to set the voltage level in real-time as the test is running under either ACW or DCW mode.



ACW	0.050kV ~ 5kV
DCW	0.050kV ~ 6kV

Results

Test judgments are the same as those for the normal manual tests. Please see the PASS/FAIL MANU Test section for details.

Page 83

Sweep Function

Sweep Function Overview

The GPT-10000 Series has access to the sweep mode function, which creates a graph of one of the ACW, DCW, IR, GB or CONT tests in either Manual test or the special MANU mode. The graph will plot the output voltage, current or resistance versus time. After the test has been completed, the test current, voltage or resistance at any point in time can be fetched and viewed in the graph.

Below is an example of the resultant sweep plot of a DCW test where a DC voltage is ramped up to a user-defined level until the HI SET current level has been tripped or the test time runs out.

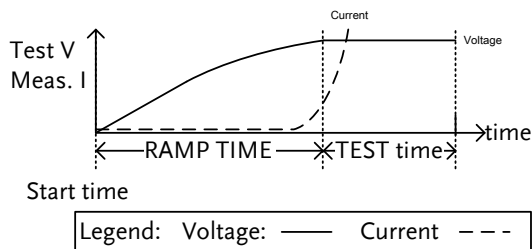

The test items that are plotted on the sweep graph depend on the type of test that is performed.

TEST	Graph Test Items
ACW	Measured voltage, measured current (V, I)
DCW	Measured voltage, measured current (V, I)
IR	Measured voltage, measured resistance (V, R)
GB	Measured current, measured resistance (I, R)
CONT	Measured current, measured resistance (I, R)

Steps of View
Sweep Graph

1. When a test has finished, press the corresponding button, e.g., DCW button for DCW test, to view the result of the sweep in an intuitive graph.

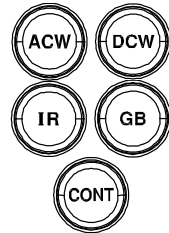

Graph Test Items:		
TEST	GREEN	BLUE
ACW	Measured voltage	Measured current
DCW	Measured voltage	Measured current
IR	Measured voltage	Measured resistance
GB	Measured current	Measured resistance
CONT	Measured current	Measured resistance

DCW Sweep
Graph Example

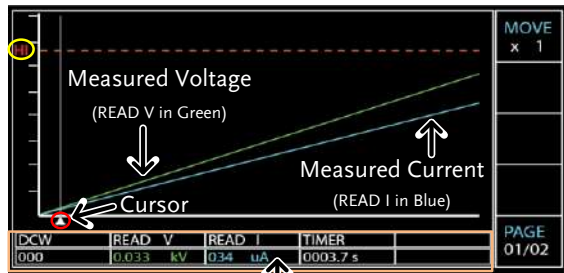

The values of point by cursor

2. Use the scroll wheel to move the cursor on the time axis (red highlight in x-axis). The measured values on the green and blue lines at that particular point in time are shown within the table below (orange highlight). Also, the test function along with the test number is clearly shown within the table. The HI in y-axis (yellow highlight) along with the dotted line in red indicates the HI SET value and the point of tripped time.

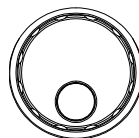

Turn Pages

3. The resultant graph will be over 1 page when test time is beyond 650 steps (the interval of each step is 0.1s). In this case, press PAGE soft-key to switch among each page for full graphs.



Fast-forward

4. Press the MOVE soft-key before moving the cursor to fast-forward steps by 10 times (x 10), which is practical when steps are many. Press the MOVE soft-key again to return back to the normal "x 1" speed.



Exit the Results Graph

To exit the sweep graph, press the corresponding button again to return back to Manual test.

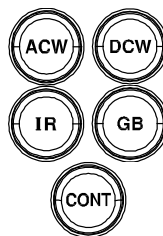

Automatic Tests

This section describes how to create, edit and run automatic tests. Automatic tests allow you to link up to 10 different MANU tests and run them sequentially within a single AUTO test. Each stored MANU test is used as a test step when creating an AUTO test. In addition, up to 5 groups of AUTO test can be interconnected together to present an ever-advanced AUTO tests.

- Choose/Recall an AUTO Test → from page 94
- Creating an AUTO Test File Name → from page 95
- Adding a Step to the AUTO Test → from page 96
- Continuous AUTO Tests → from page 98
- AUTO Test Page Editing → from page 100
- Running an Automatic Test → from page 105
- Automatic Test Results → from page 111

Before operating the GPT-12000 please read the safety precautions as outlined in the Set Up chapter on page 21.

Choose/Recall an AUTO Test

Background The tester must first be put into AUTO mode to create or run automatic tests.

Up to 100 automatic tests can be saved or recalled.

Steps

1. If the tester is in MANU or SYSTEM mode, press the AUTO key on the front panel. This will put the tester into Auto mode.



2. After entering the AUTO mode, first use the scroll wheel to choose the AUTO number.



AUTO # 001~100

AUTO number cursor READY status

AUTO_001		AUTO_NAME				READY
MANU	TEST	V/I	H/I	LOW	STEP	↑
STEP	MODE	SETTING	SETTING	SETTING	HOLD	
						↓
						←
						→

Note

The AUTO number can only be chosen in READY status. If the status is either PASS or FAIL, press the STOP button to restore back to the READY status.

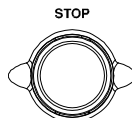

Creating an AUTO Test File Name

Background Each automatic test can have a user-defined test file name (Default: AUTO_NAME) up to 10 characters long. See the character list below for the allowed characters.

Character List

0	1	2	3	4	5	6	7	8	9	_
A	B	C	D	E	F	G	H	I	J	K
L	M	N	O	P	Q	R	S	T	U	V
W	X	Y	Z	a	b	c	d	e	f	g
h	i	j	k	l	m	n	o	p	q	r
s	t	u	v	w	x	y	z			

Steps

1. Use the LEFT/RIGHT arrow soft-keys to move the cursor to the AUTO_NAME (default name) field. The characters table will appear in the right hand accordingly.



AUTO name cursor Character Table



2. Use the scroll wheel to scroll through the available characters.



3. Press the LEFT / RIGHT arrow soft-keys to move the cursor to the next character.



- Further press the DOWN arrow key followed by using the scroll wheel to choose another MANU STEP number to add to the automatic test.



MANU STEP number cursor (2nd)

AUTO-001		AUTO_NAME			READY
MANU STEP	TEST MODE	V/I SETTING	HI SETTING	LOW SETTING	STEP HOLD
001	DCW	0.100kV	1.000mA	000 uA	P.C/F.C
002	ACW	0.100kV	1.000mA	000 uA	P.C/F.C
					SKIP
					DEL.
					STEP HOLD

- Repeat the previous steps for any other MANU tests that you wish to add to the automatic test.

Continuous AUTO Tests

Background

As mentioned previously, up to 10 MANU steps can be grouped to form an AUTO test and user can designate each step from MANU step number 1 to 100 for an AUTO test. However, it is available to interconnect different AUTO tests together to present a series of AUTO tests.

Steps

1. Follow the steps of “Adding a Step to the AUTO Test” in page 96 first. See the example below where 5 MANU steps have been added into the AUTO-001 group.

AUTO-001		AUTO_NAME				READY	
MANU STEP	TEST MODE	V/I SETTING	HI SETTING	LOW SETTING	STEP HOLD		
001	DCW	0.100kV	1.000mA	000 uA	P.C/F.H		↑
002	ACW	0.100kV	1.000mA	000 uA	P.H/F.C		↓
005	IR	0.050kV	066.8MΩ	000.1MΩ	P.C/F.S		
010	ACW	0.200kV	2.000mA	000 uA	P.C/F.C		SKIP
006	DCW	0.500kV	1.500mA	000 uA	P.H/F.S		
							DEL.
							STEP HOLD

2. Press the DOWN arrow key to bring the cursor to the next MANU STEP field followed by using the scroll wheel to choose CON from the MANU STEP options.



AUTO-001		AUTO_NAME				READY	
MANU STEP	TEST MODE	V/I SETTING	HI SETTING	LOW SETTING	STEP HOLD		
001	DCW	0.100kV	1.000mA	000 uA	P.C/F.H		↑
002	ACW	0.100kV	1.000mA	000 uA	P.H/F.C		↓
005	IR	0.050kV	066.8MΩ	000.1MΩ	P.C/F.S		
010	ACW	0.200kV	2.000mA	000 uA	P.C/F.C		SKIP
006	DCW	0.500kV	1.500mA	000 uA	P.H/F.S		
CON							DEL.
							STEP HOLD

CON is chosen from MENU STEP

- Repeat the step 1 to form another group of AUTO-002 test as the following display shown.

AUTO-002 comprising 3 MANU steps

AUTO-002		AUTO_NAME				READY	
MANU STEP	TEST MODE	V/I SETTING	HI SETTING	LOW SETTING	STEP HOLD		
001	DCW	0.100kV	1.000mA	000 uA	P.C/F.H		
002	ACW	0.100kV	1.000mA	000 uA	P.H/F.C		
003	IR	0.150kV	069.8MΩ	000.6MΩ	P.C/F.S		
						SKIP	
						DEL.	
						STEP HOLD	

- After the previous steps, return to the AUTO-001 test page followed by pressing START button for automatic test. The AUTO-002 test will ensue from the end of AUTO-001 test. The continuous AUTO tests are thus established perfectly.

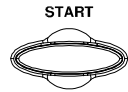

 Note

- Up to 5 groups of AUTO tests can be interconnected. The former 4 groups of AUTO tests, due to CON occupation, owns up to 9 MANU steps, respectively, whereas the last group can own up to 10 MANU steps. Thus, it is 46 MANU steps at the maximum for a continuously interconnected AUTO test.
- The interconnected groups of AUTO test are limited in serial numbers. That is to say, when initializing from AUTO-005, for example, the next group will be definitely AUTO-006 followed by AUTO-007, if available, and so forth up to 5 groups.

AUTO Test Page Editing

Background The AUTO test page contains each added MANU step (up to 10 steps) in order on the list along with the corresponding settings including Test Mode, Test V/I Setting, HI & LOW Settings as well as Step Hold action, respectively. Each step can be skipped, deleted or edited for its Step Hold actions.

Skip a MANU STEP

1. Press the UP / DOWN arrow soft-keys to bring the cursor to the target MANU STEP on list.



Target MANU STEP cursor

AUTO-001		AUTO_NAME				READY
MANU STEP	TEST MODE	V/I SETTING	HI SETTING	LOW SETTING	STEP HOLD	
001	DCW	0.100kV	1.000mA	000 uA	P.C/F.C	↑
002	ACW	0.100kV	1.000mA	000 uA	P.C/F.C	↓
						SKIP
						DEL.
						STEP HOLD

2. Press the SKIP soft-key.
3. The designated MANU STEP will be grayed out in color of setting.



The gray-out MANU STEP

AUTO-001		AUTO_NAME				READY
MANU STEP	TEST MODE	V/I SETTING	HI SETTING	LOW SETTING	STEP HOLD	
001	DCW	0.100kV	1.000mA	000 uA	P.C/F.C	↑
002	ACW	0.100kV	1.000mA	000 uA	P.C/F.C	↓
						SKIP
						DEL.
						STEP HOLD



Note

When the AUTO test is run next time, the grayed-out steps will be simply skipped.

Delete a MANU STEP

1. Press the UP / DOWN arrow soft-keys to bring the cursor to the target MANU STEP on list.



Target MANU STEP cursor

AUTO-001		AUTO_NAME				READY
MANU STEP	TEST MODE	V/I SETTING	HI SETTING	LOW SETTING	STEP HOLD	
001	DCW	0.100kV	1.000mA	000 uA	P.C/F.C	↑
002	ACW	0.100kV	1.000mA	000 uA	P.C/F.C	↓
						SKIP
						DEL.
						STEP HOLD

2. Press the DEL. soft-key.



3. The designated MANU STEP will be deleted from the list.

The designated MENU STEP is removed

AUTO-001		AUTO_NAME				READY	↑
MANU STEP	TEST MODE	V/I SETTING	HI SETTING	LOW SETTING	STEP HOLD	↓	
001	DCW	0.100kV	1.000mA	000 uA	P.C/F.C		
							SKIP
							DEL.
							STEP HOLD

Step Hold Editing

1. Press the UP / DOWN arrow soft-keys to bring the cursor to the target MANU STEP on list.



Target MANU STEP cursor

AUTO-001		AUTO_NAME				READY	↑
MANU STEP	TEST MODE	V/I SETTING	HI SETTING	LOW SETTING	STEP HOLD	↓	
001	DCW	0.100kV	1.000mA	000 uA	P.C/F.C		
002	ACW	0.100kV	1.000mA	000 uA	P.C/F.C		
							SKIP
							DEL.
							STEP HOLD

2. Press the STEP HOLD soft-key to bring the cursor to the STEP HOLD setting field.



STEP HOLD cursor

AUTO-001		AUTO_NAME			READY	
MANU STEP	TEST MODE	V/I SETTING	HI SETTING	LOW SETTING	STEP HOLD	↑
001	DCW	0.100kV	1.000mA	000 uA	P.C/F.C	↓
002	ACW	0.100kV	1.000mA	000 uA	P.C/F.C	
						SKIP
						DEL.
						STEP HOLD

3. Use the scroll wheel to choose the options from STEP HOLD setting as listed below.



P.H/F.H Step which is judged PASS will be held until START button pressed by user for next step. Step which is judged FAIL will be held until START button pressed by user for next step.

P.H/F.S Step which is judged PASS will be held until START button pressed by user for next step. The AUTO test will be immediately stopped when Step is judged FAIL.

P.H/F.C Step which is judged PASS will be held until START button pressed by user for next step. The AUTO test will automatically continue although the step is judged FAIL.

- P.C/F.H The AUTO test will automatically continue when the step is judged PASS. Step which is judged FAIL will be held until START button pressed by user for next step.
- P.C/F.S The AUTO test will automatically continue when the step is judged PASS. The AUTO test will be immediately stopped when step is judged FAIL.
- P.C/F.C The AUTO test will automatically continue when the step is judged PASS. The AUTO test will automatically continue although the step is judged FAIL.
- 0.1 ~ 999.9 s The step will be held for specified seconds (0.1 ~ 999.9s) until the next step, regardless of PASS or FAIL judgment.

Running an Automatic Test

Background An automatic test can be run when the tester is in READY status.



Note

The tester cannot start to run an AUTO test under the following conditions:

- Any protection modes have been tripped.
- The INTERLOCK function is ON and the Interlock key is not inserted in the signal I/O port (page 162).
- The STOP signal has been received remotely.

If Double Action is ON, ensure the START button is pressed immediately after the STOP button (<0.5s).



Warning

Do not touch any terminals, test leads or the DUT when a test is running.

Steps 1. Ensure the tester is in READY status for the AUTO test to come. Page 94

READY status indicator

AUTO	TEST	V/I	HI	LOW	STEP	
STEP	MODE	SETTING	SETTING	SETTING	HOLD	
001	DCW	0.100kV	1.000mA	000 uA	P.C/F.H	↑
002	ACW	0.100kV	1.000mA	000 uA	P.H/F.C	↓
005	IR	0.050kV	066.8MΩ	000.1MΩ	P.C/F.S	
010	ACW	0.200kV	2.000mA	000 uA	P.C/F.C	SKIP
006	DCW	0.500kV	1.500mA	000 uA	P.H/F.S	
						DEL.
						STEP
						HOLD

2. Press the START button when the tester is in the READY status. The AUTO test starts automatically and the display changes to each MANU TEST in sequence.

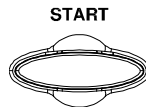

3. Each test will start by showing the ongoing ramp up time followed by the ongoing test time and the ongoing ramp down time. Each test will be tested in sequence until the last test has finished or the test is stopped.



Note

RAMP DOWN time only appears when user has activated it. See page 48 for details.

PASS & FAIL HOLD

1. If P.H (Pass Hold) or F.H (Fail Hold) is set for a MANU STEP, then the tester will “hold” the testing when a PASS or FAIL judgment for that particular MANU STEP occurs. See page 103 for more details.

PASS
HOLD
Indicator

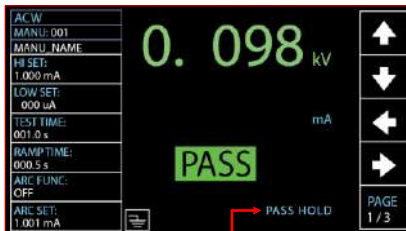

PASS HOLD indicator

FAIL
HOLD
Indicator



FAIL HOLD indicator

2. The PASS or FAIL indicator on the front panel will also be lit and the buzzer will sound accordingly.



3. To continue to the next MANU STEP after HOLD is displayed on-screen, press the START button.

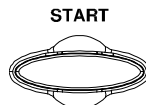

4. To stop the whole AUTO test when HOLD is displayed on-screen, press the STOP button.

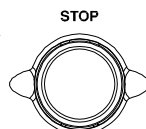



Note

When in HOLD status, only the START and STOP buttons can be pressed, all other keys are disabled.

FAIL STOP

1. If F.S (Fail Stop) is set for a MANU STEP, then the tester will “Stop” the whole AUTO test immediately when a FAIL judgment for that particular MANU STEP occurs. See page 104 for more details.

FAIL STOP Setting

AUTO_001	AUTO_NAME					REPASBY
MANU STEP	TEST MODE	V/FI SETTING	HI SETTING	LOW SETTING	STEP HOLD	
001	DCW	0.100kV	1.000mA	000 uA	P.C/F.C	
002	ACW	0.100kV	1.000mA	000 uA	P.C/F.C	
026	IR	0.150kV	069.8MΩ	000.0MΩ	P.C/F.S	
001	DCW	0.100kV	1.000mA	000 uA	P.C/F.C	SKIP
002	ACW	0.100kV	1.000mA	000 uA	P.C/F.C	
						DEL.
						STEP HOLD

FAIL STOP setting

FAIL HOLD Result Indicator

AUTO test stops in FAIL status

AUTO_001	AUTO_NAME					FAIL
MANU STEP	TEST MODE	READ DATA1	READ DATA2	TEST TIME	TEST RESULT	
001	DCW	0.099kV	000 uA	T000.3s	PASS	
002	ACW	0.099kV	000 uA	T000.3s	PASS	
026	IR	0.049kV	60.00GΩ	T000.3s	FAIL	
001	DCW	0.000kV	000 uA	I000.0s		
002	ACW	0.100kV	000 uA	I000.0s		
						PAGE 1/1

FAIL STOP indicator on exact MANU STEP

2. The FAIL indicator on the front panel will also be lit and the buzzer will sound accordingly.



3. When FAIL is displayed on-screen, press the STOP button twice to return to the READY status.

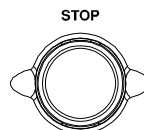

Return to
READY
status

Restore to READY status

AUTO.D01		AUTO_NAME				READY
MANU	TEST	V/I	HI	LOW	STEP	
STEP	MODE	SETTING	SETTING	SETTING	HOLD	
001	DCW	0.100kV	1.000mA	000 uA	P.C/F.C	↑
002	ACW	0.100kV	1.000mA	000 uA	P.C/F.C	↓
026	IR	0.150kV	069.8MΩ	000.6MΩ	P.C/F.S	SKIP
001	DCW	0.100kV	1.000mA	000 uA	P.C/F.C	DEL.
002	ACW	0.100kV	1.000mA	000 uA	P.C/F.C	STEP HOLD



Note

When in FAIL status, only the STOP button can be pressed, all other keys are disabled.

Stop a
Running Test

1. To stop the AUTO test at any time when it is running, press the STOP button. The AUTO test will stop immediately. When the STOP button is pressed, a judgment is not made on the current test and any remaining tests are aborted.

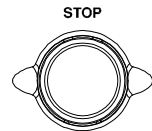

All panel keys except the STOP and START buttons are disabled when the tester has been stopped. All the results up until when the AUTO test was stopped are shown on-screen. See page 111 for more details on automatic test results.

Below is example of an automatic test that has been stopped in the midway. The remaining MANU STEPs are aborted without test results.

Automatic Test Results

Background

If all the test steps are allowed to run to completion (the AUTO test is not stopped or a protection setting is not tripped) then the tester will judge each step as either PASS or FAIL. This is shown as a table after the automatic test has finished running. If the test has been stopped, then any remaining tests will not be run and thus the AUTO test will not finish running.

Overview

AUTO TEST result indicator

AUTO-001		AUTO_NAME				TEST RESULT
MANU STEP	TEST MODE	READ DATA1	READ DATA2	TEST TIME	TEST RESULT	
001	DCW	0.099kV	000 uA	T000.3s	PASS	
002	ACW	0.099kV	000 uA	T000.3s	PASS	
001	DCW	0.000kV	000 uA	T000.0s	SKIP	
001	DCW	0.099kV	000 uA	T000.3s	PASS	
002	ACW	0.099kV	000 uA	T000.3s	PASS	
026	IR	0.049kV	60.00GΩ	T000.3s	FAIL	
001	DCW	0.097kV	000 uA	T000.1s	STOP	
002	ACW	0.000kV	000 uA	T000.3s		

PAGE 1 / 1

MANU STEP results indicators



Note

The PASS/FAIL/STOP result shown on the top-right corner for an AUTO TEST as a whole depends on the results of all the steps (MANU STEPs) that compose an AUTO TEST:

If Interlock function is enabled but without interlock inserted into Signal I/O port, the Interlock Open message will be shown on top-right corner and AUTO test will be unable to start. Refer to page 137 for details.

STOP Result

Once a MANU STEP is stopped, the AUTO TEST will be presented STOP in its result. In other words, if a MANU STEP is stopped, the entire AUTO TEST is in STOP result, neither PASS nor FAIL judgment. And the remaining MANU STEP(s) will be ignored with blank in test result field.

AUTO TEST STOP result

AUTO-001		AUTO_NAME					TEST RESULT
MANU STEP	TEST MODE	READ DATA1	READ DATA2	TEST TIME	TEST RESULT		
001	DCW	0.099kV	000 uA	T000.3s	PASS		
002	ACW	0.099kV	000 uA	T000.3s	PASS		
001	DCW	0.000kV	000 uA	T000.0s	SKIP		
001	DCW	0.099kV	000 uA	T000.3s	PASS		
002	ACW	0.099kV	000 uA	T000.3s	PASS		
026	IR	0.049kV	60.00GΩ	T000.3s	FAIL		
001	DCW	0.097kV	000 uA	T000.1s	STOP		
002	ACW	0.000kV	000 uA	T000.3s			
						PAGE 1 / 1	

One of the MANU STEPS was stopped

System Settings

The System settings are system-wide settings that apply to both MANU tests and AUTO tests.

The System menu includes the following settings:

- Display Set settings → from page 118.
- Buzzer Settings → from page 120.
- Interface Settings → from page 122.
- Control settings → from page 124.
- System Time settings → from page 138.
- Data Initialize settings → from page 142.
- Information section → from page 145.
- Statistics settings → from page 146.
- USB Disk settings → from page 148.
- Contact Check settings → from page 153.

Display Set Setting

Description The Display Set page includes both brightness level and language settings.

Steps

1. Press the SYSTEM button on the front panel when the tester is under READY status in either MANU or AUTO test.



2. The SYSTEM page will be shown where DISPLAY SET is on top of the left-side list. Press the ENTER soft-key to enter the setting page.



3. Use the scroll wheel to set the Brightness level.



LCD Brightness 1 bar (low) ~ 10 bars (high)

4. Press the UP/DOWN arrow soft-keys to move the cursor to the Language setting followed by using the scroll wheel to set the options of Language setting.



Language options English
 繁體中文 (Traditional Chinese)
 简体中文 (Simplified Chinese)

5. Press the EXIT soft-key to exit from the DISPLAY SET page.



EXIT





- The changes in DISPLAY SET are saved instantly.
- The AUTO or MANUAL button can be pressed at any time to jump to its belonging page, individually. Alternatively, it is available to promptly return back to the previous page with settings, whether it's AUTO or MANUAL mode, by simply pressing SYSTEM button.

Buzzer Settings

Description The Buzzer settings allow you to set the volume of buzzer sound for PASS/FAIL judgments. Also, it is available to set Key Sound for buttons being pressed.

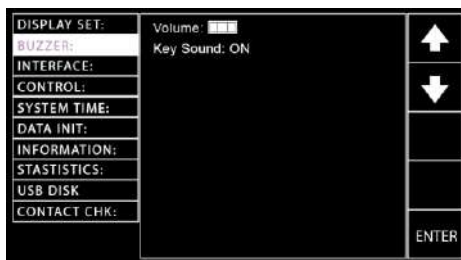
- Steps**
1. Press the SYSTEM button on the front panel when the tester is under READY status in either MANU or AUTO test. 
 2. The SYSTEM page will be shown. Press the UP/DOWN arrow soft-keys to move the cursor to the BUZZER setting. 



3. Press the ENTER soft-key to enter the Volume setting followed by using the scroll wheel to set the Volume level.  



Buzzer Volume 1 bar (low) ~ 3 bars (high)

4. Press the UP/DOWN arrow soft-keys to move the cursor to the Key Sound setting followed by using the scroll wheel to set the Key Sound setting.

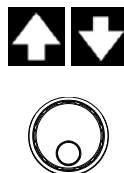

Key Sound ON, OFF

5. Press the EXIT soft-key to exit from the BUZZER page.

EXIT



Note

When in the AUTO test, the Buzzer sound only applies to the overall judgment of an AUTO test. There will no Buzzer sound for judgment of each test step within a group of an AUTO test.



Note

The changes in BUZZER setting are saved instantly.

Interface Settings

Description The interface settings allows user to choose the remote interface configuration. USB, RS232 and GPIB (optional) can be selected.

Steps

1. Press the SYSTEM button on the front panel when the tester is under READY status in either MANU or AUTO test.

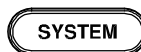

2. The SYSTEM page will be shown. Press the UP/DOWN arrow soft-keys to move the cursor to the INTERFACE setting.

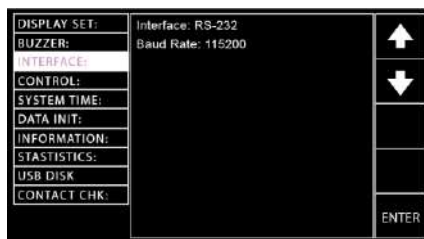

3. Press the ENTER soft-key to enter the Interface setting followed by using the scroll wheel to select the Interface options.



Interface Options

RS-232, USB, GPIB

- When RS-232 is selected, press the UP/DOWN arrow soft-keys to move the cursor to the Baud Rate setting followed by using the scroll wheel to set the Baud Rate setting.

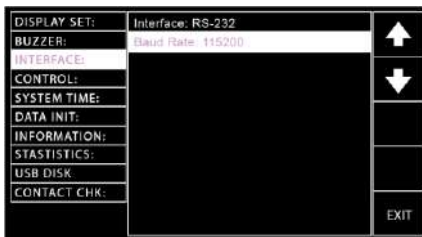
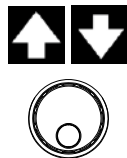

Baud Rate Setting 9600, 19200, 38400,
for RS-232 57600, 115200,

- When GPIB is selected, press the UP/DOWN arrow soft-keys to move the cursor to the Address setting followed by using the scroll wheel to set the Address setting.

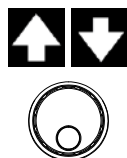

Address Setting for GPIB 00~31

- Press the EXIT soft-key to exit from the INTERFACE page.



Note

Ensure the baud rate settings or GPIB address matches the host machine.



Note

The changes in INTERFACE setting are saved instantly.

Control Settings

Description	<p>The Control settings include 7 options: Control By, Double Action, Key Lock, Interlock, Start Click For 1 Second, Power GND Check and Barcode Function Setting.</p> <ul style="list-style-type: none"><li data-bbox="370 443 934 569">• Control By is used to determine how a test is started. Tests can be started via the front panel (START/STOP buttons), from a remote controller or via the SIGNAL I/O port.<li data-bbox="370 592 927 847">• The Double Action function is a safety feature used to prevent accidentally starting a test. Normally to start a test, the START button is pressed when the tester is in the READY status. To start a test when Double Action is ON, the STOP button must first be pressed, followed by the START button within 500ms.<li data-bbox="370 869 936 1098">• Key Lock disables the front panel keys from changing the test number, mode or testing parameters. Only the START & STOP buttons required for testing are not disabled. Also, the SYSTEM button remains functional for user to return back to the system setting.<li data-bbox="370 1120 922 1313">• The Interlock function is a safety feature. The interlock function prevents a test from running, unless the interlock pins on the signal I/O port connector are shorted. The included interlock key can be used for this purpose. See page 163 for details.<li data-bbox="370 1335 936 1458">• The Start Click For 1 Second indicates another safety feature that requires the START button being pressed for 1 second so that a test, whether MANU or AUTO, can be started.
-------------	--

- The Power GND Check detects if the ground terminal from power cord of instrument connects to earth ground properly.
- Barcode Function Setting is a feature which facilitates fast yet convenient MANU and AUTO tests for, in particular, assembly line application. It enables GPT-10000 series, with additional barcode scanner plugged in, to scan barcodes and edit into a list for prompt utilization in diversified tests.

Steps

1. Press the SYSTEM button on the front panel when the tester is under READY status in either MANU or AUTO test.

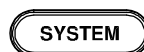

2. The SYSTEM page will be shown. Press the UP/DOWN arrow soft-keys to move the cursor to the CONTROL setting.

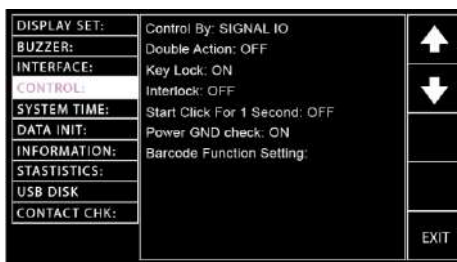

3. Press the ENTER soft-key to enter the Control By setting followed by using the scroll wheel to select the following options.



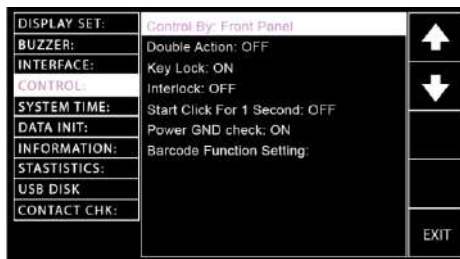

Control By settings Front Panel
 Remote
 SIGNAL IO

When SIGNAL IO is selected, press the PIN SET soft-key to enter the specific setting page.

PIN SET

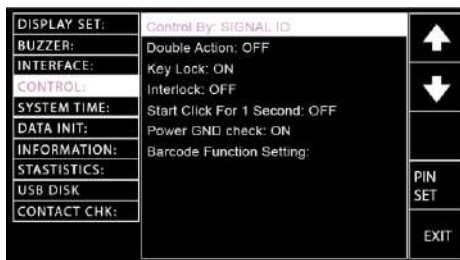

The setting page is divided into 2 sections; the upper is for output pins settings, whilst the lower part indicates the methods of Signal IO selections under AUTO test mode. Refer to the figure below.

SIGNAL IO Output PINs (green zone)

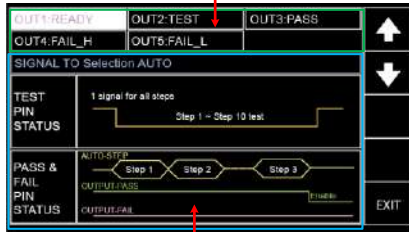

SIGNAL IO Selection for AUTO Test (blue zone)

Press the UP/DOWN arrow soft-keys to move the cursor to target PINs (1~5) followed by using the scroll wheel to select the following 6 options for each pin.

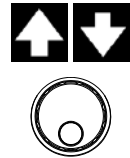

PINs READY, TEST, PASS, FAIL,
Settings FAIL_H, FAIL_L

Further press the UP/DOWN arrow soft-keys to move the cursor to the TEST PIN STATUS followed by using the scroll wheel to select the following 2 options for TEST PIN under AUTO test mode.

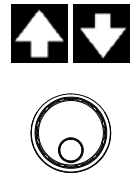

1 signal for all steps It means one signal output of TEST
for all PIN will be delivered to all steps all
steps the way till the end of an AUTO test.



1 signal for each step
for each step

It means one signal output of TEST PIN will be delivered to each step with continuous counters within each interval between each step, which is particularly practical for certain applications.



Further press the UP/DOWN arrow soft-keys to move the cursor to the PASS & FAIL PIN STATUS followed by using the scroll wheel to select the following 2 options for PASS & FAIL PINs under AUTO test mode.

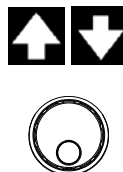

Pass & Fail judgment in final step

Regardless of judgments of each step in an AUTO test, a PASS or FAIL will be given after the whole steps are completed. However, an AUTO test will be stopped in the mid way when F.S is activated. Refer to page 103 for details.



Pass & Fail judgment for each step

Pass or Fail judgment will be given for each step within an AUTO test. By doing so, the judgments of each step can be concretely recognized, individually for user.

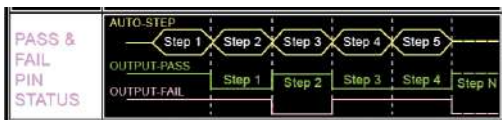

Press the UP/DOWN arrow soft-keys to move the cursor to the Double Action setting followed by using the scroll wheel to set the Double Action setting.

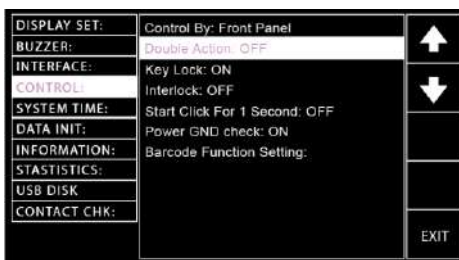

Double Action settings ON, OFF

Press the UP/DOWN arrow soft-keys to move the cursor to the Key Lock setting followed by using the scroll wheel to set the Key Lock setting.

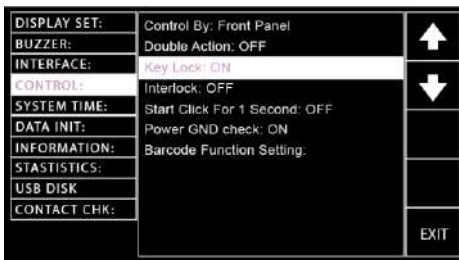

Key Lock settings ON, OFF

4. Press the UP/DOWN arrow soft-keys to move the cursor to the Interlock setting followed by using the scroll wheel to set the Interlock setting.

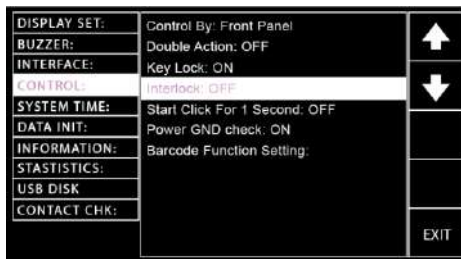

Interlock settings ON, OFF

5. Press the UP/DOWN arrow soft-keys to move the cursor to the Start Click For 1 Second setting followed by using the scroll wheel to set the Start Click For 1 Second setting.

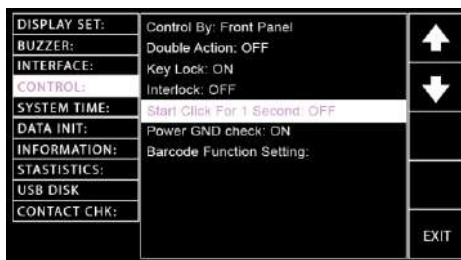

Start Click For 1 Second settings ON, OFF

6. Press the UP/DOWN arrow soft-keys to move the cursor to the Power GND Check setting followed by using the scroll wheel to set the Power GND Check setting.



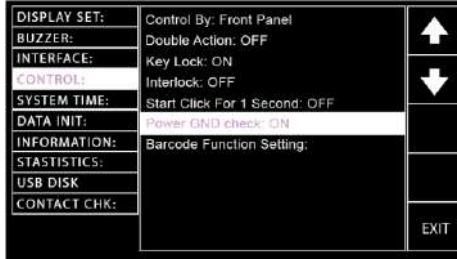

Power GND Check settings ON, OFF

When Power GND Check setting is ON but the instrument doesn't connect to earth ground, the prompt message will appear in either MANU or AUTO mode as the figures below shown.

MANU
MODE



POWER GND FAIL Message

AUTO
MODE

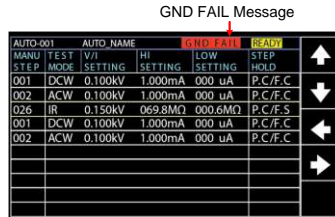

- Press the UP/DOWN arrow soft-keys to move the cursor to the Barcode Function Setting followed by pressing the SET soft-key to enter the specific setting page.



DISPLAY SET:	Control By: Front Panel	↑
BUZZER:	Double Action: OFF	
INTERFACE:	Key Lock: ON	↓
CONTROL:	Interlock: OFF	
SYSTEM TIME:	Start Click For 1 Second: OFF	SET
DATA INIT:	Power GND check: ON	
INFORMATION:	Barcode Function Setting:	EXIT
STATISTICS:		
USB DISK:		
CONTACT CHK:		

The barcode setting page is composed of a table with several columns and rows. First use the scroll wheel to choose PAGE number.



PAGE # 001~010

BAR PAGE number cursor BAR setting indicator

PAGE: 001	BAR				↓
BARCODE	TEST MODE	TEST NUM	AUTO TEST	MANU/AUTO TEST NAME	
					EXIT

Press the DOWN arrow key to bring the cursor to the PAGE table. Use a connected barcode scanner to scan a target barcode and the scanned barcode information will be written in the 1st row of the PAGE table.



The scanned barcode

PAGE: 001	BAR				↑
BARCODE	TEST MODE	TEST NUM	AUTO TEST	MANU/AUTO TEST NAME	
4710123134556			OFF		EXIT



Note

- Use an USB virtual com port-compatible barcode scanner, which plugs into the USB Host Port on the front panel of GPT-10000 series, for ideal function result.
- The length limit of barcode to be scanned is within 15 characters, which means up to 15 characters is displayed in BARCODE column for each barcode.

When a compatible barcode scanner connects to the GTP-10000 series, the corresponding icon will be shown on either MANU or AUTO display.

Barcode icon in MANU



Barcode scanner connected

Barcode icon in AUTO

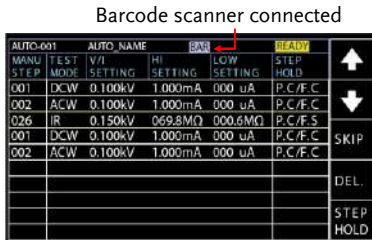

Barcode scanner connected

Use the LEFT/RIGHT arrow soft-keys to move the cursor to the TEST MODE followed by using the scroll wheel to select desired mode.

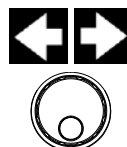

TEST MODE AUTO, MANU

Use the LEFT/RIGHT arrow soft-keys to move the cursor to the TEST NUM followed by using the scroll wheel to determine the number of selected test mode. Refer to page 40 & 94 for test number creation.

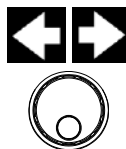

TEST NUM 001 - 100

Further use the LEFT/RIGHT arrow soft-keys to move the cursor to the AUTO TEST followed by using the scroll wheel to turn on or off the auto test function, which indicates the test will start automatically when the matched barcode is scanned later.

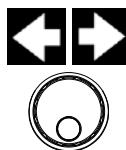

AUTO TEST ON, OFF

The MANU/AUTO NAME column automatically reflects file name corresponding to the existed file name from the selected test number in either mode. Refer to page 41 & 95 for test name creation.

Example of a scanned barcode with complete settings

The scanned barcode is set with AUTO-001 with AUTO TEST ON

PAGE 001		EDIT				
BARCODE	TEST MODE	TEST NUM	AUTO TEST	MANU/AUTO NAME		
4710123134556	AUTO	001	ON	AUTO NAME	↑	
					↓	
					←	
					→	
					EXIT	

Repeat the above steps to scan more barcodes and edit the ensuing settings if necessary.

Example of multiple scanned barcodes with complete settings

3 scanned barcodes with varied settings in PAGE-001 table

PAGE-001		BAR				
BARCODE	TEST MODE	TEST NUM	AUTO TEST	MANU/AUTO NAME		
4710123134556	AUTO	001	ON	AUTO_NAME	↑	
GPT-9801	MANU	022	OFF	MANU_NAME	↓	
ABC-abc-1234	AUTO	006	ON	AUTO_NAME	←	
					→	
					EXIT	

Delete scanned barcode from list

If you want to delete a scanned barcode, use the UP/DOWN arrow soft-keys to move the cursor to the row of target barcode followed by using the LEFT arrow soft-key to move the cursor to the BARCODE column where the target barcode is highlighted. Press the DEL. soft-key to remove it from the table.

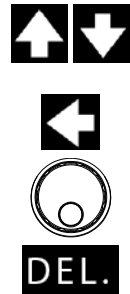

The selected barcode to be removed

PAGE-001		BAR				
BARCODE	TEST MODE	TEST NUM	AUTO TEST	MANU/AUTO NAME		
4710123134556	AUTO	001	ON	AUTO_NAME	↑	
GPT-9801	MANU	022	OFF	MANU_NAME	↓	
ABC-abc-1234	AUTO	006	ON	AUTO_NAME	←	
					→	
					DEL.	
					→	
					EXIT	

Delete soft-key

Barcode repeat

When an existed barcode is scanned again, a warning message, "Barcode Repeat" will be shown on the top-right corner with buzzer beep.

Press the EXIT soft-key to exit from the CONTROL page.



Note

The changes in CONTROL setting are saved instantly.



Note

The Double Action setting is ignored when the GPT-12000 is being controlled remotely via the USB, RS232 or GPIB interface.



Note

A beeper sounds twice when an unregistered barcode is scanned. Confirm if target barcode has been registered before barcode test operation.



Note

If a test is started with INTERLOCK ON, but the interlock signal I/O pins are not shorted (either with the included interlock key or manually), the Interlock Open message will be displayed, whether in MANU or AUTO test, to prevent the test from starting for safety reason.

MANU Test



Interlock Open Message

AUTO Test



Interlock Open Message

System Time Settings

Description The date and time for tester system can be edited under this section. The button cell battery used for system date & time has the lifecycle of approximate 2 years in general. Hence, it is suggested to replace with new battery of the type of CR-2032 every 2 years.

Steps

1. Press the SYSTEM button on the front panel when the tester is under READY status in either MANU or AUTO test.



2. The SYSTEM page will be shown. Press the UP/DOWN arrow soft-keys to move the cursor to the SYSTEM TIME setting.



3. Press the ENTER soft-key to enter the Year setting followed by using the scroll wheel to select the Year setting for system.





Year settings 2000 ~ 2099

4. Press the UP/DOWN arrow soft-keys to move the cursor to the Month setting followed by using the scroll wheel to set the Month setting for system.

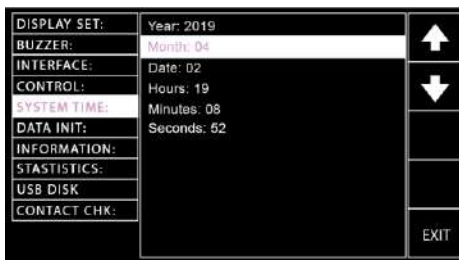

Month settings 01 ~ 12

5. Press the UP/DOWN arrow soft-keys to move the cursor to the Date setting followed by using the scroll wheel to set the Date setting for system.





Date settings 01 ~ 31

6. Press the UP/DOWN arrow soft-keys to move the cursor to the Hours setting followed by using the scroll wheel to set the Hours setting for system.

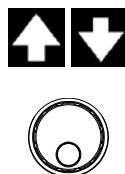

Hours settings 00 ~ 23

7. Press the UP/DOWN arrow soft-keys to move the cursor to the Minutes setting followed by using the scroll wheel to set the Minutes setting for system.

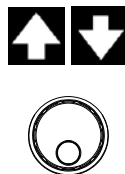



Minutes settings 00 ~ 59

8. Press the UP/DOWN arrow soft-keys to move the cursor to the Seconds setting followed by using the scroll wheel to set the Seconds setting for system.



Seconds settings 00 ~ 59

9. Press the EXIT soft-key to exit from the SYSTEM TIME page.



EXIT





The changes in SYSTEM TIME setting are saved instantly.

Data Initialize Settings

Description The settings of AUTO test, MANU test and SYSTEM saved by user can be initialized within this section.

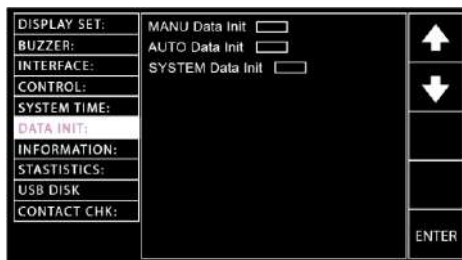
- Steps**
1. Press the SYSTEM button on the front panel when the tester is under READY status in either MANU or AUTO test. 
 2. The SYSTEM page will be shown. Press the UP/DOWN arrow soft-keys to move the cursor to the DATA INIT setting. 



3. Press the ENTER soft-key to enter the Manu Data Init setting followed by pressing the right arrow soft-key for consecutive 3 times to initialize the Manu Data settings.  

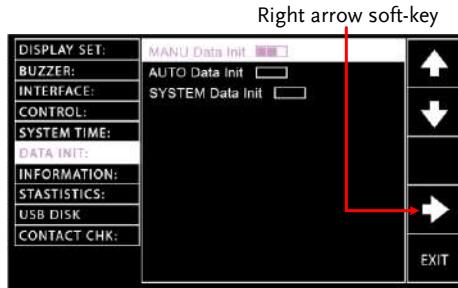

The status bar of Manu Data Init consists of 3 bars, which indicate the initializing action will not be implemented until 3 bars are fully achieved. After the initializing, the “OK” message appears.

4. Press the UP/DOWN arrow soft-keys to move the cursor to the Auto Data Init setting followed by pressing the right arrow soft-key for consecutive 3 times to initialize the Auto Data settings.

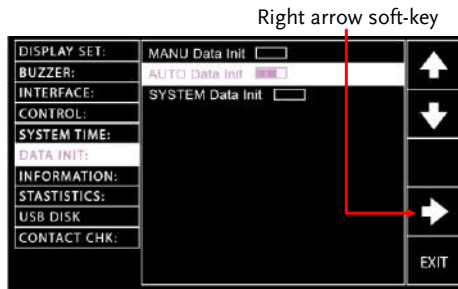
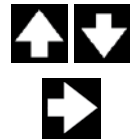

The status bar of Auto Data Init consists of 3 bars, which indicate the initializing action will not be implemented until 3 bars are fully achieved. After the initializing, the “OK” message appears.

5. Press the UP/DOWN arrow soft-keys to move the cursor to the System Data Init setting followed by pressing the right arrow soft-key for consecutive 3 times to initialize the System Data settings.

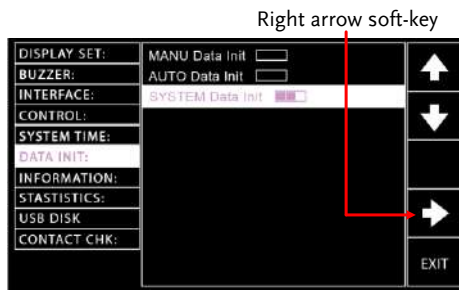
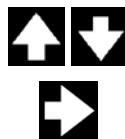



6. Press the EXIT soft-key to exit from the DATA INIT page.



The status bar of System Data Init consists of 3 bars, which indicate the initializing action will not be implemented until 3 bars are fully achieved. After the initializing, the “OK” message appears.

Information Section

Description The Information section here discloses some basic information including model name, firmware version and the available functions.



- Steps**
1. Press the SYSTEM button on the front panel when the tester is under READY status in either MANU or AUTO test. 
 2. The SYSTEM page will be shown. Press the UP/DOWN arrow soft-keys to move the cursor to the INFORMATION section. 



3. The basic information of the tester will be clearly exposed on the screen.

Statistics Settings

Description This section allows user to have a comprehensive overview of not only total test counts including PASS and FAIL amounts, individually, but also the respective counts of each test mode. More than that, user is able to view those data from an intuitive histogram.

- Steps**
1. Press the SYSTEM button on the front panel when the tester is under READY status in either MANU or AUTO test. 
 2. The SYSTEM page will be shown. Press the UP/DOWN arrow soft-keys to move the cursor to the STATISTICS setting where PASS and FAIL amounts and TOTAL amounts to date are shown in the green highlight below. Also, the detailed distributions of PASS and FAIL amounts from each test functions are well disclosed for viewing in the blue highlight below. 

PASS, FAIL amounts & TOTAL amounts

DISPLAY SET:	TOTAL AMOUNT = 00032		↑	
BUZZER:	PASS AMOUNT = 00023			
INTERFACE:	FAIL AMOUNT = 00009			
CONTROL:	FUNCTION	PASS	FAIL	↓
SYSTEM TIME:	ACW	00003	00002	
DATA INIT:	DCW	00003	00002	ENTER
INFORMATION:	IR	00002	00003	
STATISTICS:	GB	00003	00002	ENTER
USB DISK	CONT	00012	00000	
CONTACT CHK:				ENTER

PASS & FAIL amounts distributions in each test function

3. Press the ENTER soft-key to enter the statistics table. It is available to press the DATA INIT soft-key to initialize the accumulated statistics.

ENTER

**DATA
INIT**

DISPLAY SET:	TOTAL AMOUNT = 00032			↑
BUZZER:	PASS AMOUNT = 00023			
INTERFACE:	FAIL AMOUNT = 00009			
CONTROL:	FUNCTION	PASS	FAIL	↓
SYSTEM TIME:	ACW	00003	00002	
DATA INIT:	DCW	00003	00002	DATA INIT
INFORMATION:	IR	00002	00003	
STATISTICS:	GB	00003	00002	
USB DISK	CONT	00012	00000	EXIT
CONTACT CHK:				

DATA INIT soft-key



Note

After pressing the DATA INIT soft-key, all the statistics shown on this page will be initialized to 0 and the future tests will be re-accumulated from zero.

4. Press the UP/DOWN arrow soft-keys to move the cursor to the table below. Place the cursor in target test function followed by pressing ANALY soft-key to enter the specific analysis page.



ANALY

ANALY soft-key

DISPLAY SET:	TOTAL AMOUNT = 00032			↑
BUZZER:	PASS AMOUNT = 00023			
INTERFACE:	FAIL AMOUNT = 00009			
CONTROL:	FUNCTION	PASS	FAIL	↓
SYSTEM TIME:	ACW	00003	00002	
DATA INIT:	DCW	00003	00002	ANALY
INFORMATION:	IR	00002	00003	
STATISTICS:	GB	00003	00002	
USB DISK	CONT	00012	00000	EXIT
CONTACT CHK:				

Selected target test function

- The distributions of PASS and FAIL statistics are well illustrated in the histogram with table display in which the upper side reads the individual PASS and FAIL amounts for test function. The mid and lower side depicts FAIL amounts in the far-right red strip with number below, whilst the PASS amounts are described in strips of different colors with numbers below indicating the percentage of varied measured values in relation to the set HI & LOW range.

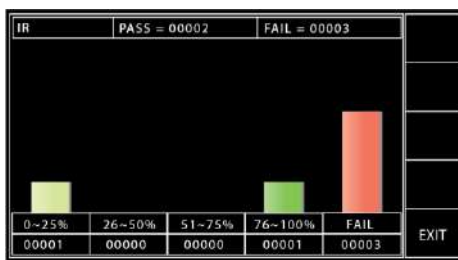

- Press the EXIT soft-key to exit from the STATISTICS page.



USB Disk Settings

Description The measurements data can be stored in the connected USB disk. In this section user can determine a user-defined name for data to be saved into the inserted USB disk. Refer to page 14 for details on USB port in the front panel.

- Steps**
- Press the SYSTEM button on the front panel when the tester is under READY status in either MANU or AUTO test.



- The SYSTEM page will be shown. Press the UP/DOWN arrow soft-keys to move the cursor to the USB DISK setting.

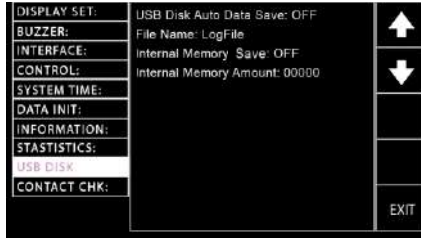

- Press the ENTER soft-key to enter the USB Disk Auto Data Save setting followed by using the scroll wheel to turn on or off the setting, which automatically saves the test data into the inserted USB disk when enabled.

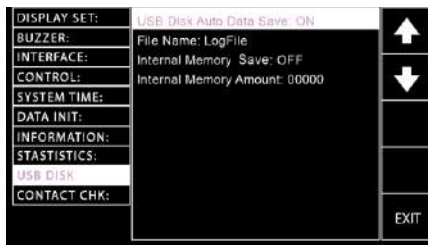

USB Disk Auto Data Save setting ON, OFF

- Press the UP/DOWN arrow soft-keys to move the cursor to the File Name filed, which sets file name for USB Disk Auto Data Save. The characters table will appear beneath accordingly.



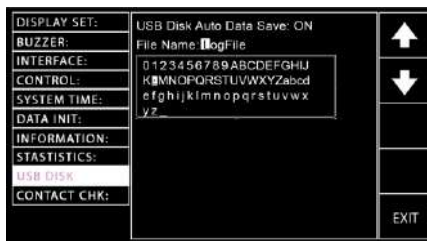

Use the scroll wheel to scroll through the available characters.



Press the LEFT / RIGHT arrow soft-keys to move the cursor to the next character and finish the naming.



5. Press the UP/DOWN arrow soft-keys to move the cursor to the Internal Memory SAVE setting followed by using the scroll wheel to turn on or off the setting, which automatically saves the test data into the internal memory of GPT-10000 series when enabled.

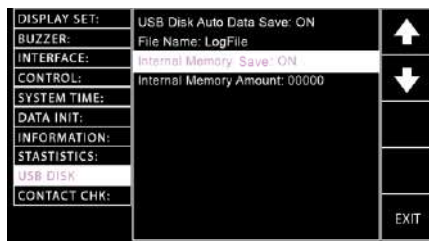

Internal Memory SAVE setting ON, OFF

6. Press the UP/DOWN arrow soft-keys to move the cursor to the Internal Memory Amount setting, which displays the total amount of test data.



DISPLAY SET:	USB Disk Auto Data Save: ON	↑
BUZZER:	File Name: LogFile	
INTERFACE:	Internal Memory Save: ON	↓
CONTROL:	Internal Memory Amount: 00000	
SYSTEM TIME:		SAVE USB
DATA INIT:		CLEAR DATA
INFORMATION:		EXIT
STATISTICS:		
USB DISK:		
CONTACT CHK:		



Note

Only when “Internal Memory SAVE” is enabled can test data be stored into the internal memory amount.

Press the SAVE USB soft-key to save test data into the inserted USB disk.

**SAVE
USB**

NO USB DISK Warning

If USB disk is Not properly inserted into GPT-10000 series, prompt message “NO USB DISK” pops up.

DISPLAY SET:	USB Disk Auto Data Save: ON	↑
BUZZER:	File Name: LogFile	
INTERFACE:	Internal Memory Save: ON	↓
CONTROL:	Internal Memory Amount: 00001	
SYSTEM TIME:	NO USB DISK	SAVE USB
DATA INIT:		CLEAR DATA
INFORMATION:		EXIT
STATISTICS:		
USB DISK:		
CONTACT CHK:		

NO TEST DATA Warning

If there is no test data available in internal memory (Amount: 00000), even though USB disk is inserted, prompt message “NO TEST DATA” pops up.

DISPLAY SET:	USB Disk Auto Data Save: ON	↑
BUZZER:	File Name: LogFile	
INTERFACE:	Internal Memory Save: ON	↓
CONTROL:	Internal Memory Amount: 00000	
SYSTEM TIME:	NO TEST DATA	SAVE USB
DATA INIT:		CLEAR DATA
INFORMATION:		EXIT
STATISTICS:		
USB DISK:		
CONTACT CHK:		

Press the CLEAR DATA soft-key to clear the internal memory amount.



NO TEST DATA Warning

If there is no test data available (Amount: 00000), prompt message “NO TEST DATA” pops up.



Note

Due to the 30,000 counts capacity limitation on internal memory amount, the warning message is shown on either MANU or AUTO mode when the maximum limitation is reached.

DATA FULL in MANU Test



Data Full Message

DATA FULL in AUTO Test

Data Full Message



Steps

1. Press the SYSTEM button on the front panel when the tester is under READY status in either MANU or AUTO test.

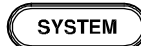

2. The SYSTEM page will be shown. Press the UP/DOWN arrow soft-keys to move the cursor to the CONTACT CHK setting.

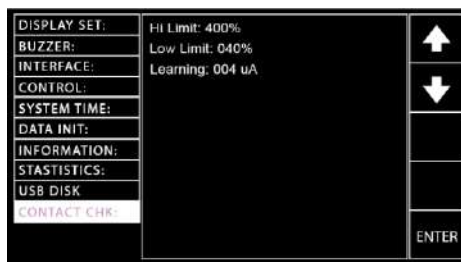

3. Press the ENTER soft-key to enter the Hi Limit setting followed by using scroll wheel to determine an exact scale of Hi Limit threshold that triggers the SHORT status warning.

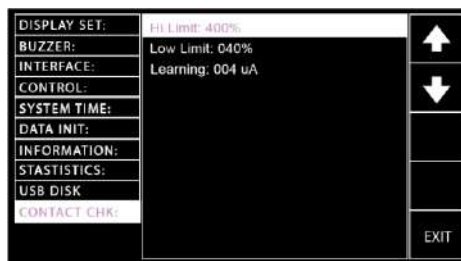

Hi Limit settings OFF, 110% ~ 500%

- Press the UP/DOWN arrow soft-keys to move the cursor to the Low Limit setting followed by using scroll wheel to determine an exact scale of Low Limit threshold that triggers the OPEN status warning.

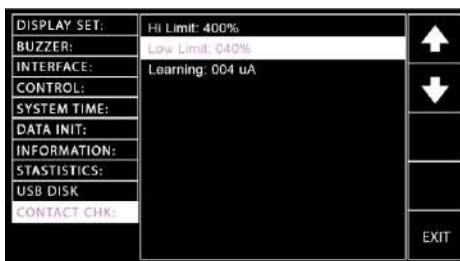

Low Limit settings 10% ~ 90%

- Press the UP/DOWN arrow soft-keys to move the cursor to the Learning setting followed by pressing the RUN soft-key to obtain the current reference value.





Note

- Prior to RUN the Learning process, be sure to well set up test leads connection between the GPT-10000 unit and the DUT.
- When reference value, for example, is defined as 4 μ A, and Hi and Low limits are set 400% and 40%, respectively, the OPEN status will be triggered when measured value is less than 1.6 μ A. The SHORT status, by contrast, will be triggered while measured value is above 16 μ A.

6. Press the EXIT soft-key to exit from the CONTACT CHK page.



Note

The changes in CONTACT CHK setting are saved instantly.

E XTERNAL CONTROL

The External Control chapter covers the
REMOTE terminal and the SIGNAL I/O port.

External Control Overview	158
Remote Terminal Overview	158
Remote Controller Operation	159
SIGNAL I/O Overview	160
Using the SIGNAL I/O to Start/Stop Tests	162
Using the Interlock Key	163

External Control Overview

The External Control section describes the front panel REMOTE terminal connection and the rear panel SIGNAL I/O port.

Remote Terminal Overview

Overview The REMOTE terminal connector is a standard 5-pin DIN terminal suitable for a remote controller.



WARNING

Keep any cables that are connected to the REMOTE terminal away from the HIGH VOLTAGE and RETURN terminals.

Pin Assignment and Connection

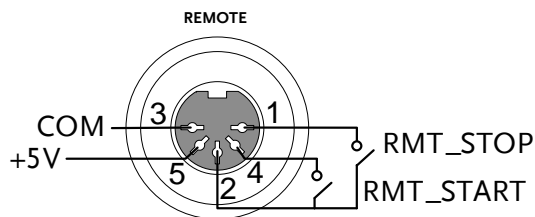

Pin	Pin name	Description
1	RMT_STOP	Remote Stop signal
2	COM	Common line
3	COM	Common line
4	RMT_START	Remote Start signal
5	+5V	+5V Output

Signal Properties

High level input voltage	3.3V~5.0V
Low level input voltage	0~0.8V
Input period	minimum of 1ms

Remote Controller Operation

Description The GPT-12000 accepts external remote controllers with a START and STOP button. To use the REMOTE terminal, the GPT-12000 must first be configured to accept a remote controller.

Operating a remote controller is the same as operating the START and STOP buttons on the front panel.

Steps

1. Insert the lead of remote controller into the REMOTE terminal.

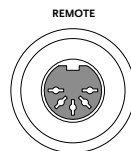

2. Configure the CONTROL option to Page 124 REMOTE in the SYSTEM mode.
 3. The tester will now only be able to start a test using a remote controller.
-



Even if the GPT-12000 is configured to use the REMOTE option, the STOP button on the front panel can still be used to stop a test.

4. To return the operation control to the front panel, configure the CONTROL option to Front Panel. Page 124

SIGNAL I/O Overview

Overview The SIGNAL I/O port can be used to remotely start/stop tests and monitor the test status of the instrument.

The SIGNAL I/O port is also used for the interlock function. Refer to page 163 for details.

The SIGNAL I/O port basically uses a DB-15 pin female connector.

Pin Assignment

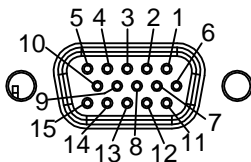

Pin name	Pin	Description
INTERLOCK1	1	When INTERLOCK is ON, a test is only allowed
INTERLOCK2	2	to start when both INTERLOCK pins are shorted.
INPUT_START	3	Start signal input
INPUT_STOP	4	Stop signal input
INPUT_COM	5	Common input line
NC	6	NC
OUTPUT_1	7	OUTPUT1 SIGNAL
OUTPUT_2	8	OUTPUT2 SIGNAL
OUTPUT_3	9	OUTPUT3 SIGNAL
OUTPUT_4	10	OUTPUT4 SIGNAL
OUTPUT_5	11	OUTPUT5 SIGNAL
NC	12	NC
NC	13	NC
NC	14	NC
OUTPUT_COM	15	Common output line

Interlock connection

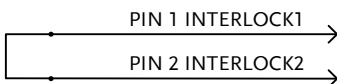

Input Connection

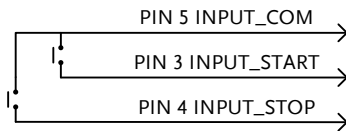

Output Connection

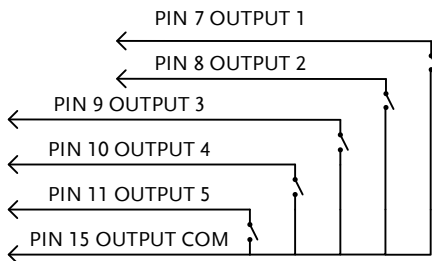

Signal Properties

Input Signals

High level input voltage	5V ~ 32V
Low level input voltage	0V ~ 1V
Low level input current	Maximum of -5mA
Input period	Minimum of 1ms

Output Signals

Output Type	Relay form A
Output Rated Voltage	30VDC
Maximum output current	0.5A

Input Stop and
Input Start
Timing

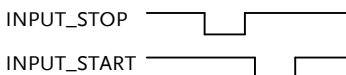

Output Timing

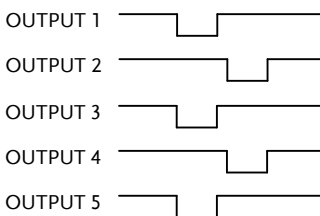

 **Note**

Output is able to be deployed by programming.

Using the SIGNAL I/O to Start/Stop Tests

Background To use the SIGNAL I/O port the CONTROL settings have to be set to SIGNAL IO in the SYSTEM mode.

- Panel operation
1. Set the CONTROL option to SIGNAL IO in the SYSTEM mode. Page 123
 2. Connect the Input/Output signals to the SIGNAL I/O port.
 3. To start the testing, short the INPUT_STOP and INPUT_COM line for a minimum of 1ms to put the tester into READY status.
 4. To start the testing, short the INPUT_START and INPUT_COM lines for a minimum of 1ms.
 5. To stop the testing, temporarily short the INPUT_STOP and INPUT_COM line again.
-



NOTE

Even if the GPT-12000 is configured to use the SIGNAL I/O interface, the STOP button on the front panel can still be used to stop a test.

Using the Interlock Key

Background When the INTERLOCK function is set to ON, tests are only allowed to start when both Interlock pins on the signal I/O port are shorted. Using the Interlock key will short the INTERLOCK1 and INTERLOCK2 pins on the signal I/O port. See page 160 for the Signal I/O pin assignment.

Panel operation 1. Insert the Interlock key into the SIGNAL I/O port on the rear panel.

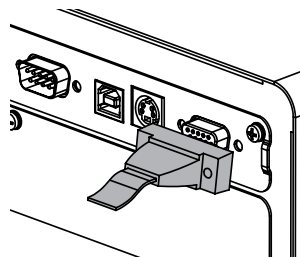

2. Set the Interlock option to ON in the SYSTEM mode. [Page 124](#)



Note

With INTERLOCK set to ON, the tester can now only start a test when the Interlock key is well connected. Do not remove the interlock after starting a test. It must be connected after a test has started or is running.

Set Interlock to OFF to disable this feature.

REMOTE CONTROL

This chapter describes basic configuration of IEEE488.2 based remote control. The remote interface supports USB, RS232 and GPIB.

Interface Configuration	165
Command Syntax	169
Command List	172
Error Messages	228

Interface Configuration

USB Remote Interface

USB Configuration	PC side connector	Type A, host
	GPT-12000 side connector	Rear panel Type B
	USB Class	CDC (communications device class) (VCP, Virtual Com Port)

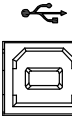
- Panel operation
1. Connect the USB cable to the rear panel USB B-Type port. 
 2. Set the Interface to USB from the SYSTEM mode. Page 121

 **Note** When USB is used for remote control, an RS232 port is simulated. Check the Windows Device Manager for the baud rate and other RS232 settings. Check the RS232 configuration below for more details.

Note the baud rate is fixed to 115200 baud when using the USB interface.

RS232 Remote Interface

RS232 Configuration	Connection	Null modem cable
	Baud rate	9600, 19200, 38400, 57600, 115200
	Parity	None
	Data bits	8

Stop bit 1

Flow control None

Pin Assignment

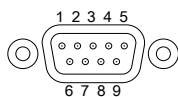

- 1: No connection
- 2: RxD (Receive Data)
- 3: TxD (Transmit Data)
- 4: No connection
- 5: GND
- 6-9: No connection

Connection	PC		Tester	
	DB9 Pin	Signal	Signal	DB9Pin
	2	RxD	TxD	3
	3	TxD	RxD	2
	5	GND	GND	5

Panel operation 1. Connect the Null modem cable to the rear panel RS232 port.

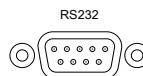

2. Set the Interface to RS-232 from the Page 121 SYSTEM mode.

GPIB Remote Interface

GPIB Configuration Address 0-31

Panel operation 1. Connect the GPIB cable to the rear panel GPIB port.

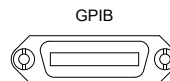

2. Set the Interface to GPIB and set the GPIB address from the Page 122 SYSTEM mode.

USB/RS232/GPIB Remote Control Function Check

Functionality
check

Invoke a terminal application such as RealTerm.

To check COM port number and other settings, see the Device Manager in PC. For WinXP; Control panel → System → Hardware tab.

Run this query command via the terminal after the instrument has been configured for USB, RS-232 or GPIB remote control.

*idn?

This should return Model number, Serial number and Firmware version in the format below:

```
GPT-12004 ,GPT12000 ,T0.01I
```

Model number : GPT-12004

Serial number :8 characters serial number

Firmware version : T0.01I

CR, LF can be used as the terminal character when entering queries/commands from a terminal application. Refer to page 171 for details.

RMT Display

When the panel is being remotely controlled via the USB, RS232 or GPIB interfaces, the RMT indicator will be displayed on the screen.



RMT indicator

Err Display

When an incorrect command is sent to the tester, the Err indicator will be displayed on the screen indicating there is an error in command.

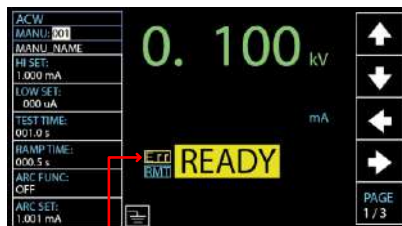

Err indicator

Return to Panel Control

Background

When the instrument is remotely controlled all panel keys except the STOP button are disabled. Receive a stop signal from either mode of Control By (Front Panel, Remote, SIGNAL IO), while the RMT indicator is displayed, or simply send a RMTOFF command (page 227) to return the instrument back to the READY status.



Note

To put the tester back to the RMT, simply issue another remote control command.

Command Syntax

Compatible Standard	IEEE488.2	Partial compatibility
	SCPI, 1999	Partial compatibility

Command Structure

SCPI commands follow a tree-like structure, organized into nodes. Each level of the command tree is a node. Each keyword in an SCPI command represents each node in the command tree. Each keyword (node) of an SCPI command is separated by a colon (:).

For example, the diagram below shows an SCPI sub-structure and a command example.



Command types

There are a number of different instrument commands and queries. A command sends instructions or data to the unit and a query receives data or status information from the unit.

Command types

Setting A single or compound command with/without a parameter

Example MANU:STEP 1

Query A query is a simple or compound command followed by a question mark (?). A parameter (data) is returned.

Example MANU:ACW:VOLTage?

Command Forms Commands and queries have two different forms, long and short. The command syntax is written with the short form of the command in capitals and the remainder (long form) in lower case.

The commands can be written in capitals or lower-case, just so long as the short or long forms are complete. An incomplete command will not be recognized.

Below are examples of correctly written commands.

Long form	SYSTEM:BUZZer:KEYSound SYSTEM:BUZZER:KEYSOUND system:buzzer:keysound
Short form	SYST:BUZZ:KEYS syst:buzz:keys

Command Format

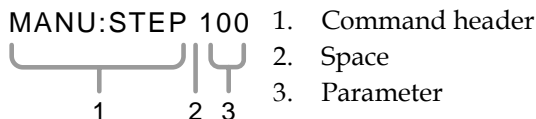

Parameters

Type	Description	Example
<Boolean>	Boolean logic	0, 1
<NR1>	integers	0, 1, 2, 3
<NR2>	decimal numbers	0.1, 3.14, 8.5

	<NR3>	floating point	4.5e-1, 8.25e+1
	<NRf>	any of NR1, 2, 3	1, 1.5, 4.5e-1
	<string>	ASCII text string	TEST_NAME
Message Terminator	CR, LF	Carriage Return, Line feed code	

Command List

System Commands

SYSTem:LCD:BRIGhtness	176
SYSTem:BUZZer:VOLUME	176
SYSTem:BUZZer:KEYSound	177
SYSTem:TIME	177
SYSTem:STATistics	177
SYSTem:ANALysis	178
SYSTem:USBDisk:AUTOSAVE	178
SYSTem:USBDisk:AMOUNT	179
SYSTem:USBDisk:FILENAME	179
SYSTem:INTERNAL:SAVE	179
SYSTem:CONtact:HILIMIT	180
SYSTem:CONtact:LOWLIMIT	180
SYSTem:CONtact:LEARNING	181
SYSTem:ERRor	181

Function Commands

FUNction:TEST	183
MEASure<x>	184
MAIN:FUNction	185
TESTok:RETURN	185

Manual Commands

MANU:STEP	188
MANU:INITial	188
MANU:NAME	189
MANU:RTIME	189
MANU:EDIT:MODE	190
MANU:ACW:VOLTage	190
MANU:ACW:CHISet	191
MANU:ACW:CLOSet	191

MANU:ACW:TTime.....	192
MANU:ACW:ARCFUNCTION	192
MANU:ACW:ARCCURRENT	194
MANU:ACW:ARCSPEED	194
MANU:ACW:FREQUENCY	194
MANU:ACW:WAITTIME.....	195
MANU:ACW:RAMPDOWN	195
MANU:ACW:GROUNDMODE.....	195
MANU:ACW:MAXHOLD	196
MANU:ACW:PASSHOLD	196
MANU:ACW:REF	197
MANU:ACW:INITVOLTAGE	197
MANU:ACW:CONTACT	197
MANU:DCW:VOLTAGE.....	198
MANU:DCW:CHISSET.....	198
MANU:DCW:CLOSET.....	199
MANU:DCW:TTime.....	200
MANU:DCW:ARCFUNCTION	201
MANU:DCW:ARCCURRENT	201
MANU:DCW:ARCSPEED	201
MANU:DCW:WAITTIME.....	202
MANU:DCW:RAMPDOWN	202
MANU:DCW:GROUNDMODE.....	203
MANU:DCW:MAXHOLD	203
MANU:DCW:PASSHOLD	203
MANU:DCW:REF	204
MANU:DCW:INITVOLTAGE	204
MANU:DCW:CONTACT	204
MANU:IR:VOLTAGE	205
MANU:IR:RHISSET.....	205
MANU:IR:RLOSET.....	206
MANU:IR:TTime	206
MANU:IR:WAITTIME.....	206
MANU:IR:RAMPDOWN	207
MANU:IR:GROUNDMODE.....	207
MANU:IR:MAXHOLD	207
MANU:IR:PASSHOLD.....	209
MANU:IR:REF	209
MANU:IR:MODE.....	210
MANU:IR:CONTACT	210

MANU:GB:CURRent	211
MANU:GB:RHISet	211
MANU:GB:RLOSet	212
MANU:GB:TTIME.....	212
MANU:GB:FREQuency	212
MANU:GB:CONtact	213
MANU:GB:GROUNDMODE	213
MANU:GB:MAXHold	213
MANU:GB:PASShold	214
MANU:GB:REF	214
MANU:GB:ZEROCHECK.....	215
MANU:CONTInuity:RHISet	215
MANU:CONTInuity:RLOSet.....	216
MANU:CONTInuity:TTIME.....	216
MANU:CONTInuity:PASShold	217
MANU:CONTInuity:REF	218
MANU:CONTInuity:ZEROCHECK	218

Auto Commands

AUTO:STEP	219
AUTO:NAME	220
AUTO:EDIT:ADD	220
AUTO<x>:EDIT:HOLD.....	221
AUTO<x>:EDIT:SKIP	221
AUTO:EDIT:DEL	222
AUTO:TEST:RETURN.....	222
AUTO:EDIT:SHOW	222

Sweep Commands

SWEEP:DATA:STATus	224
SWEEP:DATA:SHOW	224
SWEEP:GRAPH:SHOW	225

Common Commands

*CLS.....	226
*IDN	226
*SRE.....	227

Remote Commands

*RMTOFF.....	227
--------------	-----

System Commands

SYSTem:LCD:BRIGhtness	176
SYSTem:BUZZer:VOLUME	176
SYSTem:BUZZer:KEYSound	177
SYSTem:TIME	177
SYSTem:STATistics	177
SYSTem:ANALySis	178
SYSTem:USBDisk:AUTOSAVE	178
SYSTem:USBDisk:AMOUNT	179
SYSTem:USBDisk:FILENAME	179
SYSTem:INTERNAL:SAVE	179
SYSTem:CONtAct:HILIMIT	180
SYSTem:CONtAct:LOWLIMIT	180
SYSTem:CONtAct:LEARNING	181
SYSTem:ERRor	181

SYSTem:LCD:BRIGhtness

Set →
 → Query

Description	Sets the brightness of the LCD display from 1(dark) to 10(bright).
Syntax	SYSTem:LCD:BRIGhtness <NR1>
Query Syntax	SYSTem:LCD:BRIGhtness?
Parameter/ Return parameter	<NR1> 1 (dark) ~ 10 (bright)
Example	SYST:LCD:BRIG 10 Sets the display brightness to the brightest 10.

Set →
 → Query

SYSTem:BUZZer:VOLUME

Description	Sets buzzer volume from 1(low) to 3(high).
Syntax	SYSTem:BUZZer:VOLUME <NR1>
Query Syntax	SYSTem:BUZZer:VOLUME

Parameter/ Return parameter	<NR1>	1 (low) ~ 3 (high)
--------------------------------	-------	--------------------

Example SYST:BUZZ:VOLUME 3
 Sets the buzzer volume to the highest 3.

SYSTEM:BUZZer:KEYSound (Set) →
→ (Query)

Description Turns the buzzer on or off for key sound.

Syntax SYSTem:BUZZer:KEYSound {ON|OFF}

Query Syntax SYSTem:BUZZer:KEYSound?

Parameter/ Return parameter	ON	Buzzer Key Sound on.
	OFF	Buzzer Key Sound off.

Example SYST:BUZZ:KEYS ON
 Turns the buzzer on for key sound.

SYSTEM:TIME (Set) →
→ (Query)

Description Sets or Queries the system time.

Syntax SYSTem:TIME {TYY_MM_DD_hh:mm:ss}

Query Syntax SYSTem:TIME?

Parameter/ Return parameter	TYY_MM_D D_hh:mm:ss	Year (YY)_Month (MM)_Day (DD)_Hour (hh)_Minute (mm)_Second (ss)
	<string>	Returns the system date & time as a string

Example SYST:TIME T19_12_05_17_10_20
 Sets the system time as 2019-12-05 17:10:20

SYSTEM:STATistics → (Query)

Description Queries the latest statistics of PASS and FAIL.

Query Syntax SYSTem:STATistics?

Return parameter	<string>	Returns the latest statistics of all the function tests with counts of PASS and FAIL judgments respectively.
------------------	----------	--

Query Example SYST:STAT?

```
>TOTAL AMOUNT=00071
>PASS AMOUNT=00059
>FAIL AMOUNT=00012
>FUNC,PASS ,FAIL ,
>ACW ,00026,00009,
>DCW ,00000,00000,
>IR ,00017,00003,
>GB ,00000,00000,
>CONT,00016,00000,
```

SYSTem:ANALysis

→ Query

Description	Queries the latest analysis of each test function.	
Query Syntax	SYSTem:ANALysis {ACW DCW IR GB CONT}?	
Return parameter	<string>	Returns the latest analysis of the select test with PASS and FAIL judgments and distributions.

Query Example SYST:ANAL IR?

```
>IR,PASS=00017,FAIL=00003
>000~025%=00003
>026~050%=00000
>051~075%=00000
>076~100%=00014
>FAIL=00003
```

Set →

SYSTem:USBDisk:AUTOSAVE

→ Query

Description	Sets or returns the USB disk auto data save on or off.	
Syntax	SYSTem:USBDisk:AUTOSAVE {ON OFF}	
Query Syntax	SYSTem:USBDisk:AUTOSAVE?	
Parameter	ON	Turns the USB disk auto save on.

	OFF	Turns the USB disk auto save off.
Return parameter	ON	USB disk auto save on.
	OFF	USB disk auto save off.

Example SYST:USB:AUTOSAVE ON
Turns USB disk auto save on.

Set →

SYSTEM:USB:Disk:AMOUNT

→ Query

Description	Saves, clears or returns the amount of tests.	
Syntax	SYSTEM:USB:Disk:AMOUNT {SAVE CLEAR}	
Query Syntax	SYSTEM:USB:Disk:AMOUNT?	
Parameter	SAVE	Saves the amount of tests into USB disk.
	CLEAR	Clears the amount of tests from internal memory.
Return parameter	<value>	Returns the amount of tests from internal memory.

Example SYST:USB:Disk:AMOUNT SAVE
Saves the amount of tests into USB disk.

Set →

SYSTEM:USB:Disk:FILENAME

→ Query

Description	Sets or returns the data file name to be saved into the inserted USB disk. Note only alphanumeric characters (A-Z, a-z, 0-9) and the “_” underscore character can be used to set the file name.	
Syntax	SYSTEM:USB:Disk:FILENAME <"string">	
Query Syntax	SYSTEM:USB:Disk:FILENAME?	
Parameter/ Return parameter	<"String">	8 character string.

Example SYST:USB:Disk:FILENAME "File1"
Sets the data file name to "File1".

Set →

SYSTEM:INTERNAL:SAVE

→ Query

Description	Sets or returns the internal data save on or off.	
Syntax	SYSTem:INTERNAL:SAVE {ON OFF}	
Query Syntax	SYSTem:INTERNAL:SAVE?	
Parameter	ON	Turns the internal data save on.
	OFF	Turns the internal data save off.
Return parameter	ON	Internal data save on.
	OFF	Internal data save off.
Example	SYST:INTERNAL:SAVE ON Turns internal data save on.	

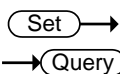

SYSTem:CONtAct:HILIMIT

Description	Sets or returns the threshold of Hi Limit scale for contact check function.	
Syntax	SYSTem:CONtAct:HILIMIT {value OFF}	
Query Syntax	SYSTem:CONtAct:HILIMIT?	
Parameter	<value>	110% ~ 500%
	OFF	Disables the threshold of Hi Limit scale.
Return parameter	<value>	110% ~ 500%
	OFF	The threshold of Hi Limit scale is disabled.
Example	SYST:CONT:HILIMIT 200% Sets the threshold of Hi Limit scale as 200% to the reference value.	

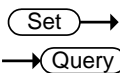

SYSTem:CONtAct:LOWLIMIT

Description	Sets or returns the threshold of Low Limit scale for contact check function.	
Syntax	SYSTem:CONtAct:LOWLIMIT {value}	
Query Syntax	SYSTem:CONtAct:LOWLIMIT?	
Parameter	<value>	10% ~ 90%
Return parameter	<value>	10% ~ 90%

Example SYST:CONT:LOWLIMIT 80%
 Sets the threshold of Low Limit scale as 80% to the reference value.

Set →

SYSTEM:CONtact:LEARNING

→ Query

Description Sets or returns the current reference value for contact check function.

Syntax SYSTEM:CONtact:LEARNING RUN

Query Syntax SYSTEM:CONtact:LEARNING?

Parameter RUN Sets the current reference value.

Return parameter <value> Returns the current reference value.

Example SYST:CONT:LEARNING RUN
 The current reference value for contact check is set.

SYSTEM:ERRor

→ Query

Description Returns error code of the previous error. See the error code table below for details.

Query Syntax SYSTEM:ERRor ?

Return parameter <string> Returns an error string that includes an error code and an error description.

Error Code Table

Error code, Error description

- 0, No Error
- 20, Command Error
- 21, Value Error
- 22, String Error
- 23, Query Error
- 24, Mode Error
- 25, TIME OVER 240s
- 26, DC Over 50W
- 27, GBV > 7.2V

- 28,ARC <= HI Set
 - 29,HI Set => ARC
 - 30,Voltage Setting Error
 - 31,Current Setting Error
 - 32,Current HI SET Error
 - 33,Current LO SET Error
 - 34,Resistance HI SET Error
 - 35,Resistance LO SET Error
 - 36,REF Setting Error
 - 37,Frequency Setting Error
 - 38,ARC Setting Error
 - 39,RAMP Time Setting Error
 - 40,TEST Time Setting Error
 - 41,WAIT Time Setting Error
 - 42,RAMP Down Setting Error
 - 43,PASS Hold Setting Error
 - 44,GB Contact Setting Error
 - 45,Setting Over 200W
 - 46,CONT Setting Over 8V
 - 47,Auto Step Add Full
 - 48,This Is The Last Step
 - 49,Auto Connect Set Error
-

Example

SYST:ERR ?

>0,No Error

Returns "0,No Error" as the error message.

Function Commands

FUNcTion:TEST	183
MEASure<x>	184
MAIN:FUNcTion.....	185
TSETok:RETURN	185

FUNcTion:TEST

Set →

← Query

Description Turns the currently selected test (output) on or off.

When HOLD is displayed on the screen during AUTO tests, use the FUNcTion:TEST command to move on to the next step.

Setting the FUNcTion:TEST command to OFF at the end of a test will also temporarily turn the PASS/FAIL buzzer sound off.

Syntax	FUNcTion:TEST {ON OFF}	
Query Syntax	FUNcTion:TEST?	
Parameter	ON	Turns the test on.
	OFF	Turns the test off.
Return parameter	TEST ON	Test is on.
	TEST OFF	Test is off.
Example	FUNC:TEST ON Turns the output on.	

MEASure<x>

→ **Query**

Description Returns the test parameters & results of the tester in either MANU or AUTO mode.

MANU mode: Returns the test parameters & results of a MANU test.

AUTO mode: Returns the test parameters & results of the selected step (1-50) of the AUTO test.

Return parameters: function, judgment/status, test voltage, test current/resistance, test time (time of completed test) or ramp time (elapsed time of test that has not been completed).

Query Syntax	MEASure<x>?	
Parameter (MANU mode)		No parameter needed for MANU mode.
Parameter (AUTO mode)	<x>	<NR1>1~50. MANU Step number.
Return parameter	<string>	Returns the test status of the test in the following format: function, judgment or status, test voltage, test current or resistance, test time or ramp time
	Function	ACW, DCW, IR, GB, CON
	Judgment /Status	PASS, FAIL VIEW
	Test voltage	voltage+unit
	Test current /Test resistance	current+unit resistance+unit
	Test time /Ramp time	T=time+s R=time+s

Example (in MANU mode) MEAS?
> CON,FAIL ,100.0mA,99.99 ohm,T=000.1s
Returns the test result of the current MANU test.

Example MEAS21?
 (in AUTO mode) > DCW,FAIL ,0.004kV, 000.0 uA ,T=000.3s
 Returns the step 21 of the current AUTO test result.

Set →

MAIN:FUNction

→ Query

Description Changes the mode between AUTO and MANU.

Syntax MAIN:FUNction {MANU|AUTO}

Query Syntax MAIN:FUNction ?

Parameter/ MANU Puts the tester mode to MANU.

Return parameter AUTO Puts the tester mode to AUTO.

Example MAIN:FUNC MANU
 Sets the tester to MANU mode.

Set →

TESTok:RETURN

→ Query

Description Turns on or off the "OK" message for test result, which is shown when a test finishes.

Syntax TESTok:RETURN {ON|OFF}

Query Syntax TESTok:RETURN ?

Parameter/ ON Turns on the "OK" message for test result.

Return parameter OFF Turns off the "OK" message for test result.

Example TEST:RETURN ON
 Turns on the OK message return function.

Manual Commands

MANU:STEP.....	188
MANU:INITial	188
MANU:NAME.....	189
MANU:RTIME	189
MANU:EDIT:MODE.....	190
MANU:ACW:VOLTage	190
MANU:ACW:CHISet.....	191
MANU:ACW:CLOSet.....	191
MANU:ACW:TTIME	192
MANU:ACW:ARCFUNCTION	192
MANU:ACW:ARCCurrent.....	194
MANU:ACW:ARCSpeed	194
MANU:ACW:FREQuency	194
MANU:ACW:WAITtime.....	195
MANU:ACW:RAMPdown	195
MANU:ACW:GROUNDMODE.....	195
MANU:ACW:MAXHold.....	196
MANU:ACW:PASShold.....	196
MANU:ACW:REF	197
MANU:ACW:INITvoltage.....	197
MANU:ACW:CONTACT	197
MANU:DCW:VOLTage	198
MANU:DCW:CHISet.....	198
MANU:DCW:CLOSet.....	199
MANU:DCW:TTIME	200
MANU:DCW:ARCFUNCTION	201
MANU:DCW:ARCCurrent.....	201
MANU:DCW:ARCSpeed	201
MANU:DCW:WAITtime.....	202
MANU:DCW:RAMPdown	202
MANU:DCW:GROUNDMODE.....	203
MANU:DCW:MAXHold.....	203
MANU:DCW:PASShold.....	203
MANU:DCW:REF	204
MANU:DCW:INITvoltage.....	204
MANU:DCW:CONTACT	204

MANU:IR:VOLTage	205
MANU:IR:RHISet	205
MANU:IR:RLOSet	206
MANU:IR:TTime	206
MANU:IR:WAITtime	206
MANU:IR:RAMPdown	207
MANU:IR:GROUNDMODE	207
MANU:IR:MAXHold	207
MANU:IR:PASShold	209
MANU:IR:REF	209
MANU:IR:MODE	210
MANU:IR:CONTACT	210
MANU:GB:CURREnt	211
MANU:GB:RHISet	211
MANU:GB:RLOSet	212
MANU:GB:TTime	212
MANU:GB:FREQuency	212
MANU:GB:CONtact	213
MANU:GB:GROUNDMODE	213
MANU:GB:MAXHold	213
MANU:GB:PASShold	214
MANU:GB:REF	214
MANU:GB:ZEROCHECK	215
MANU:CONTInuity:RHISet	215
MANU:CONTInuity:RLOSet	216
MANU:CONTInuity:TTime	216
MANU:CONTInuity:PASShold	217
MANU:CONTInuity:REF	218
MANU:CONTInuity:ZEROCHECK	218

Set →

→ Query

MANU:STEP

Description	Sets the MANU test number.
Syntax	MANU:STEP <NR1>
Query Syntax	MANU:STEP?
Parameter/ Return parameter	<NR1> 0~100
Example	MANU:STEP 100 Sets the manual test number to 100.

MANU:INITial

Set →

Description	Loads the initial (default) settings for the selected MANU test number. The initial settings that are loaded depend on the test function (ACW, DCW, IR, GB or CONT).
-------------	--

Syntax	MANU:INITial					
Initial Settings		Function				
	Parameter	ACW	DCW	IR	GB	CONT
	REF#	000uA	000uA	000.0M Ω	000.0m Ω	00.00Ω
	FREQ	60Hz	X	X	60Hz	X
	HI SET	1.000mA	1.000mA	OFF	100.0m Ω	01.00Ω
	LOW SET	000uA	000uA	001.0M Ω	000.0m Ω	00.00Ω
	I or V	V=0.100 kV	V=0.100 kV	V=0.050 kV	03.00A	100mA
	TEST TIME	000.3s	000.3s	000.3s	000.3s	000.3s
	RAMP TIME	000.1s	000.1s	000.1s	X	X

Example	MANU:INITial Loads the initial settings for the selected MANU number.
---------	--

MANU:NAME

Description Sets or returns the test name for the selected manual test. The test must be in MANU mode before this command can be used.

Note only alphanumeric characters (A-Z, a-z, 0-9) and the “_” underscore character can be used to set the MANU test name.

Syntax MANU:NAME <”string”>

Query Syntax MANU:NAME?

Parameter/ <”string”> 10 character string.
Return parameter

Example MANU:NAME “test1”
 Sets the manual test name to “test1”.

MANU:RTIME

Description Sets or returns the Ramp Up time for ACW, DCW and IR tests in seconds.

Note: An “Err” message will be shown on display if the Ramp Time + Test Time is > 240 seconds when the HI SET limit is $\geq 30\text{mA}$. This applies to the ACW function only. An “TIME OVER 240s” message will be returned after using the query command “SYSTEM:ERROR ?” in remote control.

Note: When tester is in GB or CONT mode, due to without RAMP TIME setting, only an “Err” message will be shown if issuing this remote command.

Syntax MANU:RTIME <NR2>

Query Syntax MANU:RTIME?

Parameter/ <NR2> 0.1~999.9 seconds
Return parameter

Example MANU:RTIM 0.5
 Sets the ramp time to half a second.

Set →

MANU:EDIT:MODE

→ Query

Description Sets or returns the mode (ACW, DCW, IR, GB, CONT) of the selected manual test.

Syntax MANU:EDIT:MODE {ACW|DCW|IR|GB|CONT}

Query Syntax MANU:EDIT:MODE?

Parameter/ ACW AC Withstand mode

Return parameter DCW DC Withstand mode

IR Insulation Resistance mode

GB Ground Bond mode

CONT Continuity mode

Example MANU:EDIT:MODE ACW
 Sets the mode to ACW.

Set →

MANU:ACW:VOLTage

→ Query

Description Sets or returns the ACW voltage in kV. The test must first be in ACW mode before this command can be used.

Syntax MANU:ACW:VOLTage <NR2>

Query Syntax MANU:ACW:VOLTage?

Parameter/ <NR2> 0.050 ~ 5.100 (kV)

Return parameter

Example MANU:ACW:VOLT 1
 Sets the ACW voltage to 1 kV.

MANU:ACW:CHISet (Set) →
→ (Query)

Description Sets or returns the ACW HI SET current value in milliamps. The test must first be in ACW mode before this command can be used.

Syntax MANU:ACW:CHISet <NR2>

Query Syntax MANU:ACW:CHISet?

**Parameter/
Return parameter** <NR2> 0.001 ~ 42.00 (mA)

Example MANU:ACW:CHIS 30.0
Sets the ACW HI SET current to 30 mA.

MANU:ACW:CLOSet (Set) →
→ (Query)

Description Sets or returns the ACW LOW SET current value in milliamps. The LOW SET value must be less than the HI SET value. The test must first be in ACW mode before this command can be used.

The LOW SET range must use the HI SET range. If all the digits in the LOW SET range are outside the HI SET range, an Err message will be produced. All digits outside the HI SET range are ignored and will not be used.

For example:

HI SET value: 30.00

LOW SET value: 30.01 → error

Syntax MANU:ACW:CLOSet <NR2>

Query Syntax MANU:ACW:CLOSet?

**Parameter/
Return parameter** <NR2> 0.000 ~ 41.90 (mA)

Example MANU:ACW:CLOS 20.0
Sets the ACW LO SET current to 20 mA.

Set →

→ Query

MANU:ACW:TTIME

Description Sets or returns the ACW test time in seconds. The test must first be in ACW mode before this command can be used.

Note: An “Err” message will be shown on display if the Ramp Time + Test Time is > 240 seconds when the HI SET limit is ≥ 30mA. This applies to the ACW function only. An “TIME OVER 240s” message will be returned after using the query command “SYSTem:ERRor ?” in remote control.

Syntax MANU:ACW:TTIME {<NR2>|OFF}

Query Syntax MANU:ACW:TTIME?

Parameter	<NR2>	0.3 ~ 999.9 seconds
	OFF	TIMER OFF

Return parameter	<NR2>	0.3 ~ 999.9 seconds
	TIME OFF	TIMER is OFF

Example MANU:ACW:TTIM 1
Sets the ACW test time to 1 second.

Set →

→ Query

MANU:ACW:ARCFUNCTION

Description Sets or returns the ACW ARC function. The test must first be in ACW mode before this command can be used. Note that this command is only workable when ARC SET>HI SET.

Syntax MANU:ACW:ARCFUNCTION

Query Syntax {OFF|ON_CONT|ON_STOP}

MANU:ACW:ARCFUNCTION?

Parameter/	OFF	ARC function off
Return parameter	ON_CONT	ARC function ON & CONT
	ON_STOP	ARC function ON & STOP

Example

MANU:ACW:ARCF OFF

Sets the ACW ARC function off.

MANU:ACW:ARCCurrent

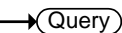

Description	Sets or returns the ACW ARC current value in mA. ARC must be enabled before the ARC current can be set. The test must first be in ACW mode before this command can be used.
Syntax	MANU:ACW:ARCCurrent <NR2>
Query Syntax	MANU:ACW:ARCCurrent?
Parameter/ Return parameter	<NR2> 1.000 ~ 80.00mA
Example	MANU:ACW:ARCC 1.233 Sets the ACW ARC value to 1.233 mA.

MANU:ACW:ARCSpeed



Description	Sets or returns the ACW ARC speed. ARC must be enabled before the ARC speed can be set. The test must first be in ACW mode before this command can be used.
Syntax	MANU:ACW:ARCSpeed {FAST NORMAL SLOW}
Query Syntax	MANU:ACW:ARCSpeed?
Parameter/ Return parameter	FAST ARC speed fast NORMAL ARC speed normal SLOW ARC speed slow
Example	MANU:ACW:ARCS SLOW Sets the ACW ARC speed slow.

MANU:ACW:FREQuency



Description	Sets or returns the ACW test frequency in Hz. The test must first be in ACW mode before this command can be used.
-------------	---

Syntax	MANU:ACW:FREQuency {50 60}	
Query Syntax	MANU:ACW:FREQuency?	
Parameter/	50	50 Hz
Return parameter	60	60 Hz
Example	MANU:ACW:FREQ 50 Sets the ACW test frequency to 50Hz.	

MANU:ACW:WAITtime (Set) →
→ (Query)

Description	Sets or returns the ACW wait time in seconds. The test must first be in ACW mode before this command can be used.	
Syntax	MANU:ACW:WAITtime <NR2>	
Query Syntax	MANU:ACW:WAITtime?	
Parameter/	<NR2>	0 ~ 999.9 seconds
Return parameter		
Example	MANU:ACW:WAIT 10.1 Sets the ACW wait time to 10.1 s.	

MANU:ACW:RAMPdown (Set) →
→ (Query)

Description	Sets or returns the ACW Ramp Down Time in seconds. The test must first be in ACW mode before this command can be used.	
Syntax	MANU:ACW:RAMPdown <NR2>	
Query Syntax	MANU:ACW:RAMPdown?	
Parameter/	<NR2>	0 ~ 999.9 seconds
Return parameter		
Example	MANU:ACW:RAMP 999.9 Sets the ramp down time to 999.9 seconds.	

MANU:ACW:GROUNDMODE (Set) →
→ (Query)

Description	Sets or returns the ACW Ground Mode. The test must first be in ACW mode before this command can be used.	
Syntax	MANU:ACW:GROUNDMODE {ON OFF}	
Query Syntax	MANU:ACW:GROUNDMODE?	
Parameter/ Return parameter	ON OFF	ACW Ground Mode ON ACW Ground Mode OFF
Example	MANU:ACW:GROUNDMODE OFF Sets the ACW Ground Mode off.	

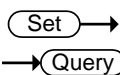

MANU:ACW:MAXHold

Description	Sets or returns the ACW MAX Hold. The test must first be in ACW mode before this command can be used.	
Syntax	MANU:ACW:MAXHold {ON OFF}	
Query Syntax	MANU:ACW:MAXHold?	
Parameter/ Return parameter	ON OFF	ACW MAX Hold ON ACW MAX Hold OFF
Example	MANU:ACW:MAXH OFF Sets the ACW MAX Hold off.	

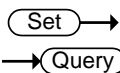

MANU:ACW:PASShold

Description	Sets or returns the duration of ACW PASS Hold in seconds. The test must first be in ACW mode before this command can be used.	
Syntax	MANU:ACW:PASShold {<NR2> ON}	
Query Syntax	MANU:ACW:PASShold?	
Parameter/ Return parameter	<NR2> ON	0 ~ 999.9 seconds Indefinite duration
Example	MANU:ACW:PASS 999.9 Sets the ACW PASS Hold time to 999.9 seconds.	

		Set →
		→ Query
MANU:ACW:REF		
Description	Sets or returns the ACW reference value in uA or mA. The test must first be in ACW mode before this command can be used.	
	The ACW reference value shares the identical limit of HI SET value, which is 42mA at the maximum. For instance, when HI SET value is set 10mA, the reference value can therefore be set up to 32mA.	
Syntax	MANU:ACW:REF <NR2>	
Query Syntax	MANU:ACW:REF?	
Parameter/ Return parameter	<NR2> 0.000 ~ 41.00 (mA)	
Example	MANU:ACW:REF 40 Sets the ACW reference to 40 mA.	

		Set →
		→ Query
MANU:ACW:INITvoltage		
Description	Sets or returns the ACW percentage of initial voltage. The test must first be in ACW mode before this command can be used.	
Syntax	MANU:ACW:INITvoltage <NR1>	
Query Syntax	MANU:ACW:INITvoltage?	
Parameter/ Return parameter	<NR1> 0 ~ 99%	
Example	MANU:ACW:INIT 87 Sets the ACW Initial Voltage to 87%.	

		Set →
		→ Query
MANU:ACW:CONTACT		
Description	Sets or returns the CONTACT CHK function on or off.	
Syntax	MANU:ACW:CONTACT {ON OFF}	
Query Syntax	MANU:ACW:CONTACT?	

Parameter/	ON	CONTACT CHK in ACW test ON
Return parameter	OFF	CONTACT CHK in ACW test OFF

Example MANU:ACW:CONTACT OFF
 Sets the CONTACT CHK off in ACW test.

Set →

MANU:DCW:VOLTage

→ Query

Description Sets or returns the DCW voltage in kV. The test must first be in DCW mode before this command can be used.

Note: An "Err" message will be shown on display if the DCW Voltage X HI SET value is > 50 watts. An "DC Over 50W" message will be returned after using the query command "SYSTEM:ERRor ?" in remote control.

Syntax MANU:DCW:VOLTage <NR2>

Query Syntax MANU:DCW:VOLTage?

Parameter/	<NR2>	0.050 ~ 6.100 (kV)
Return parameter		

Example MANU:DCW:VOLT 6
 Sets the DCW voltage to 6 kV.

Set →

MANU:DCW:CHISet

→ Query

Description Sets or returns the DCW HI SET current value in milliamps. The test must first be in DCW mode before this command can be used.

Note: An "Err" message will be shown on display if the DCW Voltage X HI SET value is > 50 watts. An "DC Over 50W" message will be returned after using the query command "SYSTEM:ERRor ?" in remote control.

Syntax MANU:DCW:CHISet <NR2>

Query Syntax MANU:DCW:CHISet?

Parameter/ Return parameter	<NR2>	0.001 ~ 11.00 (mA)
--------------------------------	-------	--------------------

Example MANU:DCW:CHIS 5
 Sets the DCW HI SET current to 5mA.

Set →

→ Query

MANU:DCW:CLOSet

Description Sets or returns the DCW LOW SET current value in milliamps. The LOW SET value must be less than the HI SET value. The test must first be in DCW mode before this command can be used.

The LOW SET range must use the HI SET range. If all the digits in the LOW SET range are outside the HI SET range, an Err will be produced. All digits outside the HI SET range are ignored and will not be used.

For example:

HI SET value: 10.99

LOW SET value: 11.00 → error

Syntax MANU:DCW:CLOSet<NR2>

Query Syntax MANU:DCW:CLOSet?

Parameter/ Return parameter	<NR2>	0.000 ~ 10.99 (mA)
--------------------------------	-------	--------------------

Example MANU:DCW:CLOS 2.00
 Sets the DCW LO SET current to 2mA.

Set →

→ Query

MANU:DCW:TTIMe

Description	Sets or returns the DCW test time in seconds. The test must first be in DCW mode before this command can be used.	
Syntax	MANU:DCW:TTIMe {<NR2> OFF}	
Query Syntax	MANU:DCW:TTIMe?	
Parameter	<NR2>	0.3 ~ 999.9 seconds
	OFF	TIMER OFF
Return parameter	<NR2>	0.3 ~ 999.9 seconds
	TIME OFF	TIMER is OFF
Example	MANU:DCW:TTIM 1 Sets the DCW test time to 1 second.	

		Set →
		→ Query
MANU:DCW:ARCFunction		
Description	Sets or returns the DCW ARC function. The test must first be in DCW mode before this command can be used. Note that this command is only workable when ARC SET>HI SET.	
Syntax	MANU:DCW:ARCFunction	
Query Syntax	{OFF ON_CONT ON_STOP}	
	MANU:DCW:ARCFunction?	
Parameter/ Return parameter	OFF	ARC function off
	ON_CONT	ARC function ON & CONT
	ON_STOP	ARC function ON & STOP
Example	MANU:DCW:ARCF OFF Sets the DCW ARC function off.	

		Set →
		→ Query
MANU:DCW:ARCCurrent		
Description	Sets or returns the DCW ARC current value in mA. ARC must be enabled to set the ARC current. The test must first be in DCW mode before this command can be used.	
Syntax	MANU:DCW:ARCCurrent <NR2>	
Query Syntax	MANU:DCW:ARCCurrent?	
Parameter/ Return parameter	<NR2>	1.000 ~ 80.00 (mA)
Example	MANU:DCW:ARCC 10 Sets the DCW ARC value to 10mA.	

		Set →
		→ Query
MANU:DCW:ARCSpeed		
Description	Sets or returns the DCW ARC speed. ARC must be enabled before the ARC speed can be set. The test must first be in DCW mode before this command can be used.	

Syntax	MANU:DCW:ARCSpeed {FAST NORMAL SLOW}	
Query Syntax	MANU:DCW:ARCSpeed?	
Parameter/ Return parameter	FAST	ARC speed fast
	NORMAL	ARC speed normal
	SLOW	ARC speed slow
Example	MANU:DCW:ARCS SLOW Sets the DCW ARC speed slow.	

Set →

MANU:DCW:WAITtime

→ Query

Description	Sets or returns the DCW wait time in seconds. The test must first be in DCW mode before this command can be used.	
Syntax	MANU:DCW:WAITtime <NR2>	
Query Syntax	MANU:DCW:WAITtime?	
Parameter/ Return parameter	<NR2>	0 ~ 999.9 seconds
Example	MANU:DCW:WAIT 10.1 Sets the DCW wait time to 10.1 s.	

Set →

MANU:DCW:RAMPdown

→ Query

Description	Sets or returns the DCW Ramp Down Time in seconds. The test must first be in DCW mode before this command can be used.	
Syntax	MANU:DCW:RAMPdown <NR2>	
Query Syntax	MANU:DCW:RAMPdown?	
Parameter/ Return parameter	<NR2>	0 ~ 999.9 seconds
Example	MANU:DCW:RAMP 999.9 Sets the DCW ramp down time to 999.9 seconds.	

MANU:DCW:GROUNDMODE

Set →

→ Query

Description Sets or returns the DCW Ground Mode. The test must first be in DCW mode before this command can be used.

Syntax MANU:DCW:GROUNDMODE {ON|OFF}

Query Syntax MANU:DCW:GROUNDMODE?

Parameter/	ON	DCW Ground Mode ON
Return parameter	OFF	DCW Ground Mode OFF

Example MANU:DCW:GROUNDMODE OFF
Sets the DCW Ground Mode off.

Set →

→ Query

MANU:DCW:MAXHold

Description Sets or returns the DCW MAX Hold. The test must first be in DCW mode before this command can be used.

Syntax MANU:DCW:MAXHold {ON|OFF}

Query Syntax MANU:DCW:MAXHold?

Parameter/	ON	DCW MAX Hold ON
Return parameter	OFF	DCW MAX Hold OFF

Example MANU:DCW:MAXH OFF
Sets the DCW MAX Hold off.

Set →

→ Query

MANU:DCW:PASShold

Description Sets or returns the duration of DCW PASS Hold. The test must first be in DCW mode before this command can be used.

Syntax MANU:DCW:PASShold {<NR2>|ON}

Query Syntax MANU:DCW:PASShold?

Parameter/	<NR2>	0 ~ 999.9 seconds
Return parameter	ON	Indefinite duration

Example MANU:DCW:PASS 999.9
 Sets the DCW PASS Hold time to 999.9 seconds.

Set →

MANU:DCW:REF

→ Query

Description Sets or returns the DCW reference value in uA or mA. The test must first be in DCW mode before this command can be used.

The DCW reference value shares the identical limit of HI SET value, which is 11mA at the maximum. For instance, when HI SET value is set 5mA, the reference value can therefore be set up to 6mA.

Syntax MANU:DCW:REF <NR2>
 Query Syntax MANU:DCW:REF?
 Parameter/
 Return parameter <NR2> 0.000 ~ 10.00 (mA)

Example MANU:DCW:REF 10
 Sets the DCW reference to 10 mA.

Set →

MANU:DCW:INITvoltage

→ Query

Description Sets or returns the DCW percentage of initial voltage. The test must first be in DCW mode before this command can be used.

Syntax MANU:DCW:INITvoltage <NR1>
 Query Syntax MANU:DCW:INITvoltage?
 Parameter/
 Return parameter <NR1> 0 ~ 99%

Example MANU:DCW:INIT 87
 Sets the DCW Initial Voltage to 87%.

Set →

MANU:DCW:CONTACT

→ Query

Description Sets or returns the CONTACT CHK function on or off.

Syntax	MANU:DCW:CONTACT {ON OFF}	
Query Syntax	MANU:DCW:CONTACT?	
Parameter/ Return parameter	ON OFF	CONTACT CHK in DCW test ON CONTACT CHK in DCW test OFF
Example	MANU:DCW:CONTACT OFF Sets the CONTACT CHK off in DCW test.	

MANU:IR:VOLTage

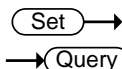

Description	Sets or returns the IR voltage in kV. The test must first be in IR mode before this command can be used.	
Syntax	MANU:IR:VOLTage <NR2>	
Query Syntax	MANU:IR:VOLTage?	
Parameter/ Return parameter	<NR2>	0.05 ~ 1.2 (0.05kV to 1.2kV: steps of .05)
Example	MANU:IR:VOLT 1 Sets the IR voltage to 1 kV.	

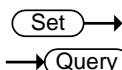

MANU:IR:RHISet

Description	Sets or returns the IR HI SET resistance value in MΩ or GΩ. The test must first be in IR mode before this command can be used.	
Syntax	MANU:IR:RHISet <NR2> NULL	
Query Syntax	MANU:IR:RHISet?	
Parameter/ Return parameter	<NR2>	000.2M ~ 999.9M (Ω) 1.000G ~ 9.999G (Ω) 10.00G ~ 50.00G (Ω)
	NULL	Sets the HI SET value to OFF.
Example	MANU:IR:RHIS 10M Sets the IR HI SET resistance to 10 MΩ.	

MANU:IR:RLOSet

Set →

→ Query

Description	Sets or returns the IR LO SET resistance value in MΩ or GΩ. The LO SET value must be less than the HI SET value. The test must first be in IR mode before this command can be used.
Syntax	MANU:IR:RLOSet<NR2>
Query Syntax	MANU:IR:RLOSet?
Parameter/ Return parameter	<NR1> 000.1M ~ 999.9M (Ω) 1.000G ~ 9.999G (Ω) 10.00G ~ 50.00G (Ω)
Example	MANU:IR:RLOS 10M Sets the IR LO SET resistance to 10MΩ.

Set →

→ Query

MANU:IR:TTIME

Description	Sets or returns the IR test time in seconds. The test must first be in IR mode before this command can be used.
Syntax	MANU:IR:TTIME <NR2>
Query Syntax	MANU:IR:TTIME?
Parameter/ Return parameter	<NR2> 0.3 ~ 999.9 seconds
Example	MANU:IR:TTIM 1 Sets the IR test time to 1 second.

Set →

→ Query

MANU:IR:WAITtime

Description	Sets or returns the IR wait time in seconds. The test must first be in IR mode before this command can be used.
Syntax	MANU:IR:WAITtime <NR2>
Query Syntax	MANU:IR:WAITtime?

Parameter/ Return parameter	<NR2>	0 ~ 999.9 seconds
--------------------------------	-------	-------------------

Example MANU:IR:WAIT 10.1
Sets the IR wait time to 10.1 s.

Set →

MANU:IR:RAMPdown

→ Query

Description Sets or returns the IR Ramp Down Time in seconds. The test must first be in IR mode before this command can be used.

Syntax MANU:IR:RAMPdown <NR2>

Query Syntax MANU:IR:RAMPdown?

Parameter/ Return parameter	<NR2>	0 ~ 999.9 seconds
--------------------------------	-------	-------------------

Example MANU:IR:RAMP 999.9
Sets the IR ramp down time to 999.9 seconds.

Set →

MANU:IR:GROUNDMODE

→ Query

Description Sets or returns the IR Ground Mode. The test must first be in IR mode before this command can be used.

Syntax MANU:IR:GROUNDMODE {ON|OFF}

Query Syntax MANU:IR:GROUNDMODE?

Parameter/ Return parameter	ON	IR Ground Mode ON
	OFF	IR Ground Mode OFF

Example MANU:IR:GROUNDMODE OFF
Sets the IR Ground Mode off.

Set →

MANU:IR:MAXHold

→ Query

Description Sets or returns the IR MAX Hold. The test must first be in IR mode before this command can be used.

Syntax MANU:IR:MAXHold {ON|OFF}

Query Syntax MANU:IR:MAXHold?

Parameter/	ON	IR MAX Hold ON
------------	----	----------------

Return parameter	OFF	IR MAX Hold OFF
------------------	-----	-----------------

Example MANU:IR:MAXH OFF

 Sets the IR MAX Hold off.

MANU:IR:PASShold

Set →

→ Query

Description Sets or returns the duration of IR PASS Hold. The test must first be in IR mode before this command can be used.

Syntax MANU:IR:PASShold {<NR2>|ON}

Query Syntax MANU:IR:PASShold?

Parameter/ <NR2> 0 ~ 999.9 seconds

Return parameter ON Indefinite duration

Example MANU:IR:PASS 999.9

Sets the IR PASS Hold time to 999.9 seconds.

Set →

MANU:IR:REF

→ Query

Description Sets or returns the IR reference value in M Ω or G Ω . The test must first be in IR mode before this command can be used.

Syntax MANU:IR:REF <NR2>

Query Syntax MANU:IR:REF?

Parameter/ <NR2> 000.0M ~ 999.9M (Ω)

Return parameter 1.000G ~ 9.999G (Ω)

10.00G ~ 50.00G (Ω)

Example MANU:IR:REF 900M

Sets the IR reference to 900 M Ω .

MANU:IR:MODE

Set →

→ Query

Description	Sets or returns the IR Mode in IR. The test must first be in IR mode before this command can be used.	
Syntax	MANU:IR:MODE	
Query Syntax	{STOP_ON_FAIL STOP_ON_PASS TIMER}	
	MANU:IR:MODE?	
Parameter/ Return parameter	STOP_ON_FAIL	IR Mode in Stop On FAIL
	STOP_ON_PASS	IR Mode in Stop On PASS
	TIMER	IR Mode in Timer
Example	MANU:IR:MODE TIMER Sets the IR Mode in Timer setting.	

Set →



→ Query

MANU:IR:CONTACT

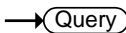
Description	Sets or returns the CONTACT CHK function on or off.	
Syntax	MANU:IR:CONTACT {ON OFF}	
Query Syntax	MANU:IR:CONTACT?	
Parameter/ Return parameter	ON	CONTACT CHK in IR test ON
	OFF	CONTACT CHK in IR test OFF
Example	MANU:IR:CONTACT OFF Sets the CONTACT CHK off in IR test.	

MANU:GB:CURRent	
Description	Sets or returns the GB current in A. The test must first be in GB mode before this command can be used.
Syntax	MANU:GB:CURREnt <NR2>
Query Syntax	MANU:GB:CURREnt?
Parameter/ Return parameter	<NR2> 3.00~33.00
Example	MANU:GB:CURR 3.00 Sets the GB current to 3.00A.

MANU:GB:RHISet	
Description	Sets or returns the GB HI SET resistance value in mΩ. The test must first be in GB mode before this command can be used.
Syntax	MANU:GB:RHISet <NR2>
Query Syntax	MANU:GB:RHISet?
Parameter/ Return parameter	<NR2> 000.1 ~ 650.0 (mΩ)
Example	MANU:GB:RHIS 100.0 Sets the GB HI SET value to 100mΩ.



Note

If the GB current x (HI SET resistance + REF) > 7.2V, an “Err” message will be shown on display. And an “GBV > 7.2V” message will be returned after using the query command “SYSTem:ERRor ?” in remote control.

MANU:GB:RLOSet

Set →

→ Query

Description	Sets or returns the GB LOW SET resistance value in mΩ. The LOW SET value must be less than the HI SET value. The test must first be in GB mode before this command can be used.
Syntax	MANU:GB:RLOSet<NR2>
Query Syntax	MANU:GB:RLOSet?
Parameter/ Return parameter	<NR2> 0.000 ~ 649.9 (mΩ)
Example	MANU:GB:RLOS 50 Sets the GB LO SET resistance to 50mΩ.

MANU:GB:TTIME

Set →

→ Query

Description	Sets or returns the GB test time in seconds. The test must first be in GB mode before this command can be used.
Syntax	MANU:GB:TTIME <NR2>
Query Syntax	MANU:GB:TTIME?
Parameter/ Return parameter	<NR2> 0.3 ~ 999.9 seconds
Example	MANU:GB:TTIM 1 Sets the GB test time to 1 second.

MANU:GB:FREQuency

Set →

→ Query

Description	Sets or returns the GB test frequency in Hz. The test must first be in GB mode before this command can be used.
Syntax	MANU:GB:FREQuency {50 60}
Query Syntax	MANU:GB:FREQuency?
Parameter/ Return parameter	50 50 Hz

Return parameter 60 60 Hz

Example MANU:GB:FREQ 50
Sets the GB test frequency to 50Hz.

Set →

MANU:GB:CONtact

→ Query

Description Sets or returns the GB Contact Time in seconds. The test must first be in GB mode before this command can be used.

Syntax MANU:GB:CONtact <NR2>

Query Syntax MANU:GB:CONtact?

Parameter/ Return parameter <NR2> 0 ~ 999.9 seconds

Example MANU:GB:CONtact 999.9
Sets the GB Contact time to 999.9 seconds.

Set →

MANU:GB:GROUNDMODE

→ Query

Description Sets or returns the GB Ground Mode. The test must first be in GB mode before this command can be used.

Syntax MANU:GB:GROUNDMODE {ON|OFF}

Query Syntax MANU:GB:GROUNDMODE?

Parameter/ Return parameter ON GB Ground Mode ON
OFF GB Ground Mode OFF

Example MANU:GB:GROUNDMODE OFF
Sets the GB Ground Mode off.

Set →

MANU:GB:MAXHold

→ Query

Description Sets or returns the GB MAX Hold. The test must first be in GB mode before this command can be used.

Syntax	MANU:GB:MAXHold {ON OFF}	
Query Syntax	MANU:GB:MAXHold?	
Parameter/ Return parameter	ON OFF	GB MAX Hold ON GB MAX Hold OFF
Example	MANU:GB:MAXH OFF Sets the GB MAX Hold off.	

Set →

→ Query

MANU:GB:PASShold

Description	Sets or returns the duration of GB PASS Hold. The test must first be in GB mode before this command can be used.	
Syntax	MANU:GB:PASShold {<NR2> ON}	
Query Syntax	MANU:GB:PASShold?	
Parameter/ Return parameter	<NR2> ON	0 ~ 999.9 seconds Indefinite duration
Example	MANU:GB:PASS 999.9 Sets the GB PASS Hold time to 999.9 seconds.	

Set →

→ Query

MANU:GB:REF

Description	Sets or returns the GB reference value in mΩ. The test must first be in GB mode before this command can be used. Beware that when ISET x (HIEST + REF) is greater than 7.2V, an “Err” message will be shown on display. And an “GBV > 7.2V” message will be returned after using the query command “SYSTEM:ERRor ?” in remote control.	
Syntax	MANU:GB:REF <NR2>	
Query Syntax	MANU:GB:REF?	
Parameter/ Return parameter	<NR2>	0.000 ~ 650.0 (mΩ)

Example MANU:GB:REF 100
 Sets the GB reference to 100 m Ω .

Set →

MANU:GB:ZEROCHECK

→ Query

Description Performs the zero check function. The test must first be in GB mode and in the Ready Status before this command can be used.

See page 69 for details on the ZERO function.

Syntax MANU:GB:ZEROCHECK {ON|OFF}

Query Syntax MANU:GB:ZEROCHECK?

Parameter/ Return parameter	ON	Zero function is active.
	OFF	Zero function is not active.

Example MANU:GB:ZEROCHECK OFF
 Activates the GB ZERO function.

Set →

MANU:CONTinuity:RHISet

→ Query

Description Sets or returns the CONT HI SET resistance value in Ω . The test must first be in CONT mode before this command can be used.

Syntax MANU:CONTinuity:RHISet <NR2>

Query Syntax MANU:CONTinuity:RHISet?

Parameter/ Return parameter	<NR2>	00.01 ~ 80.00 Ω
--------------------------------	-------	------------------------

Example MANU:CONT:RHIS 30.0
 Sets the CONT HI SET resistance to 30 Ω .

Set →

MANU:CONTinuity:RLOSet

→ Query

Description Sets or returns the CONT LOW SET resistance value in Ω . The LOW SET value must be less than the HI SET value. The test must first be in CONT mode before this command can be used.

The LOW SET range must use the HI SET range. If all the digits in the LOW SET range are outside the HI SET range, an Err message will be produced. All digits outside the HI SET range are ignored and will not be used.

For example:

HI SET value: 10.00

LOW SET value: 10.01 → error

Syntax MANU:CONTinuity:RLOSet <NR2>

Query Syntax MANU:CONTinuity:RLOSet?

Parameter/Return parameter <NR2> 00.00 ~ 79.99 Ω

Example MANU:CONT:RLOS 20.0
Sets the CONT LO SET resistance to 20 Ω .

Set →

MANU:CONTinuity:TTIME

→ Query

Description Sets or returns the CONT test time in seconds. The test must first be in CONT mode before this command can be used.

Syntax MANU:CONTinuity:TTIME <NR2>

Query Syntax MANU:CONTinuity:TTIME?

Parameter <NR2> 0.3 ~ 999.9 seconds

Return parameter <NR2> 0.3 ~ 999.9 seconds

Example MANU:CONT:TTIM 1
Sets the CONT test time to 1 second.

MANU:CONTInuity:PASShold

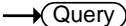
Description	Sets or returns the duration of CONT PASS Hold. The test must first be in CONT mode before this command can be used.	
Syntax	MANU:CONTInuity:PASShold {<NR2> ON}	
Query Syntax	MANU:CONTInuity:PASShold?	
Parameter/	<NR2>	0 ~ 999.9 seconds
Return parameter	ON	Indefinite duration
Example	MANU:CONT:PASS 999.9 Sets the CONT PASS Hold time to 999.9 seconds.	

MANU:CONTinuity:REF

Set →

→ Query

Description Sets or returns the CONT reference value in Ω . The test must first be in CONT mode before this command can be used.

Note: when HI SET+REF VALUE is over 80 Ω , an "Err" message will be shown on display. And an "CONT Setting Over 8V" message will be returned after using the query command "SYSTem:ERRor?" in remote control.

Syntax MANU:CONTinuity:REF <NR2>

Query Syntax MANU:CONTinuity:REF?

Parameter/ Return parameter <NR2> 00.00 ~ 79.99 Ω

Example MANU:CONT:REF 0.01
Sets the CONT reference to 00.01 Ω .

Set →

→ Query

MANU:CONTinuity:ZEROCHECK

Description Performs the zero check function. The test must first be in CONT mode and in the Ready Status before this command can be used.

See page 69 for details on the ZERO function.

Syntax MANU:CONTinuity:ZEROCHECK {ON|OFF}

Query Syntax MANU:CONTinuity:ZEROCHECK?

Parameter/ Return parameter ON Zero function is active.
OFF Zero function is not active.

Example MANU:CONT:ZEROCHECK OFF
Deactivates the CONT ZERO function.

Auto Commands

AUTO:STEP	219
AUTO:NAME	220
AUTO:EDIT:ADD	220
AUTO<x>:EDIT:HOLD	221
AUTO<x>:EDIT:SKIP	221
AUTO:EDIT:DEL	222
AUTO:TEST:RETURN	222
AUTO:EDIT:SHOW	222

AUTO:STEP

Set →

→ Query

Description	Sets or queries the AUTO number (automatic test number).
Syntax	AUTO:STEP <NR1>
Query Syntax	AUTO:STEP?
Parameter/ Return parameter	<NR1> 1~100
Example	AUTO:STEP 100 Sets the current AUTO number to 100

Set →

→ Query

AUTO:NAME

Description Sets or returns the AUTO name for the selected automatic test. The test must be in AUTO mode before this command can be used.

Note only alphanumeric characters (A-Z, a-z, 0-9) and the “_” underscore character can be used to set the AUTO test name.

Syntax AUTO:NAME <"string">

Query Syntax AUTO:NAME?

Parameter/ <"string"> 10 character string.
Return parameter

Example AUTO:NAME "program1"
 Sets the AUTO name to "program1".

AUTO:EDIT:ADD

Set →

Description Add the selected MANU test to the current AUTO number.

Syntax AUTO:EDIT:ADD {<NR1>|CON}

Parameter/ <NR1> 1~100
 CON Continuous step

Example AUTO:EDIT:ADD 7
 Adds MANU STEP 007 to the current AUTO number.

AUTO<x>:EDIT:HOLD



Description	Sets or returns the actions for STEP HOLD of each MANU STEP in AUTO test.	
Syntax	AUTO<x>:EDIT:HOLD {PH_FH PH_FS PH_FC PC_FH PC_FS PC_FC}	
Query Syntax	AUTO<x>:EDIT:HOLD?	
Parameter/	<x>	MAMU step 1 ~ 10
Return parameter	PH_FH	Sets Pass Hold & Fail Hold action
	PH_FS	Sets Pass Hold & Fail Stop action
	PH_FC	Sets Pass Hold & Fail Continue action
	PC_FH	Sets Pass Continue & Fail Hold action
	PC_FS	Sets Pass Continue & Fail Stop action
	PC_FC	Sets Pass Continue & Fail Continue action
Example	AUTO1:EDIT:HOLD PH_FH Sets the Pass Hold & Fail Hold action for MANU STEP 1 in the current AUTO test.	

AUTO<x>:EDIT:SKIP



Description	Sets or returns the SKIP action for each MANU STEP in AUTO test.	
Syntax	AUTO<x>:EDIT:SKIP {ON OFF}	
Query Syntax	AUTO<x>:EDIT:SKIP?	
Parameter/	<x>	Sets MANU STEP from 1 - 10 for skip
Return parameter	ON	Turns SKIP action for the designated MANU STEP on
	OFF	Turns SKIP action for the designated MANU STEP off
Example	AUTO1:EDIT:SKIP ON Enables SKIP function for MANU STEP 1 in AUTO test.	

AUTO:EDIT:DEL

Set →

Description	Deletes the designated MANU STEP within the current AUTO test.	
Syntax	AUTO:EDIT:DEL {<NR1> ALL}	
Parameter	<NR1>	Deletes selected MANU STEP from 1 - 10
	ALL	Deletes all the MANU STEPs
Example	AUTO:EDIT:DEL 3 Deletes the MANU STEP 3 from the current AUTO test.	

AUTO:TEST:RETURN

→ Query

Description	Returns the number of AUTO test and MANU STEP that is being tested currently.	
Query Syntax	AUTO:TEST:RETURN?	
Return parameter	String	The returned string will be in the format of AUTO number followed by MANU STEP number. AUTO-XXX,STEP-XX
Example	AUTO:TEST:RETURN? AUTO-004,STEP-03 The MANU STEP-03 of AUTO-004 is being tested.	

AUTO:EDIT:SHOW

→ Query

Description	Returns all the information of the current AUTO test page.	
Query Syntax	AUTO:EDIT:SHOW?	
Return parameter	String	The returned strings will be shown in the way almost identical to the contents displayed on an AUTO test page.

Example AUTO:EDIT:SHOW?
>AUTO-001 AUTO_NAME
>STEP,MODE,V/I SET,HI SET ,LOW SET,STEP HOLD
> _____
>001 ,ACW ,0.100kV,1.000mA,000 uA,P.C/F.C
>001 ,ACW ,0.100kV,1.000mA,000 uA,P.C/F.C
>001 ,ACW ,0.100kV,1.000mA,000 uA,P.C/F.C
>001 ,ACW ,0.100kV,1.000mA,000 uA,P.C/F.C
>001 ,ACW ,0.100kV,1.000mA,000 uA,P.C/F.C
>001 ,ACW ,0.100kV,1.000mA,000 uA,P.C/F.C
>001 ,ACW ,0.100kV,1.000mA,000 uA,P.C/F.C
>001 ,ACW ,0.100kV,1.000mA,000 uA,P.C/F.C
>001 ,ACW ,0.100kV,1.000mA,000 uA,P.C/F.C
>001 ,ACW ,0.100kV,1.000mA,000 uA,P.C/F.C

Sweep Commands

SWEEP:DATA:STATus	224
SWEEP:DATA:SHOW	224
SWEEP:GRAPH:SHOW	225

SWEEP:DATA:STATus

→ Query

Description	Returns the basic status of get data.
Query Syntax	SWEEP:DATA:STA?
Return parameter	<String> The returned string will be in the format below: STEP, TEST MODE, V SET, HI SET, TOTAL DATA
Example	SWEEP:DATA:STA? > STEP, MODE, V SET , HI SET , TOTAL DATA 000 , DCW , 0.450kV, 1.700mA, 00076

SWEEP:DATA:SHOW

→ Query

Description	Returns the full measured readings of get data.
Query Syntax	SWEEP:DATA:SHOW<NR1>
Return parameter	<NR1> 0~10000 0 stands for the full steps. 1~10000 indicates the designated step.
Example	SWEEP:DATA:SHOW 0 > TIMER , READ V, READ I 0000.1s , 0.003kV, 007uA 0000.2s , 0.008kV, 026uA 0000.3s , 0.019kV, 064uA 0000.4s , 0.028kV, 095uA 0000.5s , 0.037kV, 126uA 0000.6s , 0.045kV, 153uA

SWEEP:GRAPh:SHOW

Set →

→ Query

Description Displays or turns off Sweep graph on LCD screen.
Also Returns if Sweep graph is shown on LCD.

Syntax SWEEP:GRAPh:SHOW {ON|OFF}

Query Syntax SWEEP:GRAPh:SHOW?

Parameter/ Return parameter	ON	To enable Sweep graph on LCD
	OFF	To disable Sweep graph on LCD
	?	Returns if Sweep graph is shown on LCD

Example SWEEP:GRAP:SHOW?
 > OFF
 Sweep graph is Not displayed on LCD screen.

Common Commands

*CLS.....	226
*IDN.....	226
*SRE.....	227

*CLS

Set →

Description	The *CLS command clears the internal registers and error message, if any.
Syntax	*CLS

*IDN

→ Query

Description	Queries the model number, serial number, and firmware version of the tester.		
Query Syntax	*IDN?		
Return parameter	<table> <tr> <td><string></td> <td>Returns the instrument identification as a string in the following format: >GPT-12004 ,GPT12000 ,T0.011 Model number : GPT-12004 Serial number :8 characters serial number Firmware version : T0.011</td> </tr> </table>	<string>	Returns the instrument identification as a string in the following format: >GPT-12004 ,GPT12000 ,T0.011 Model number : GPT-12004 Serial number :8 characters serial number Firmware version : T0.011
<string>	Returns the instrument identification as a string in the following format: >GPT-12004 ,GPT12000 ,T0.011 Model number : GPT-12004 Serial number :8 characters serial number Firmware version : T0.011		

***SRE** → Query

Description AUTO MODE only. Use this command to get measurement step number at the current point in time during AUTO MODE testing.

Query Syntax *SRE?

Return parameter <NR1> 00~50

Example *SRE?
>5
The current test step is number 5. This indicates that steps 1~4 have already been completed and the results for those steps can now be retrieved.

Remote Commands

*RMTOFF.....227

***RMTOFF** Set →

Description This command can be used to terminate a remote session. When this command is used "RMT" will no longer be displayed on the front panel, indicating that remote mode has been terminated.

Syntax *RMTOFF

Error Messages

Background The possible error messages returned from SYST:ERR? query are well listed below.

Error	Error Code
No Error	0
Command Error	20
Value Setting Error	21
String Setting Error	22
Query Error	23
MODE Setting Error	24
TIME OVER 240s	25
DC Over 50W	26
GBV > 7.2V	27
ARC <= HI Set	28
HI Set => ARC	29
Voltage Setting Error	30
Current Setting Error	31
Current HI Set Error	32
Current LO Set Error	33
Resistance HI Set Error	34
Resistance LO Set Error	35
REF Setting Error	36
Frequency Setting Error	37
ARC Setting Error	38
RAMP Time Setting Error	39
TEST Time Setting Error	40
WAIT Time Setting Error	41
RAMP Down Setting Error	42
PASS Hold Setting Error	43
GB Contact Setting Error	44
Setting Over 200W	45
CONT Setting Over 8V	46
Auto Step Add Full	47
This Is The Last Step	48
Auto Connect Set Error	49

F AQ

-
- The tester will not turn on.
 - The panel keys are not working.
 - The measured value of IR, GB or Continuity test does not match the specification.
 - When I press the START button the tester will not start testing?

The tester will not turn on?

Ensure the power cord is connected. Check and make sure the fuse is not blown and properly installed. See page 232.

The panel keys are not working?

Ensure the tester is not in the SIGNAL I/O or Remote Control mode (page 123). If it is, refer to page 168 for how to return to front panel control. Also, if Key Lock is enabled, all panel keys except START and STOP are disabled. Refer to page 124 for details.

The measured value of IR test does not match the specification?

Make sure the tester is powered on for warm-up of at least 30 minutes, within +15°C~+35°C. This is necessary to stabilize the tester to match the specification. After warm-up, please proceed to Contact Check procedure.

The measured value of GB test does not match the specification?

Make sure the tester is powered on for warm-up of at least 30 minutes, within +15°C~+35°C. This is necessary to stabilize the

tester to match the specification. After warm-up, please proceed to Zero Check procedure. Refer to page 69 for details.

The measured value of Continuity test does not match the specification?

Make sure the tester is powered on for warm-up of at least 30 minutes, within +15°C~+35°C. This is necessary to stabilize the tester to match the specification. After warm-up, please proceed to Zero Check procedure. Refer to page 69 for details.

When I press the START button the tester will not start testing?

The tester must first be in the READY status before a test can be started. Ensure the tester displays READY before pressing the START button, page 78 (manual test), 105 (automatic test).

If Double Action is enabled, the START button must be pressed within 0.5 seconds after the STOP button is pressed, otherwise the tester will not start testing.

If Interlock is enabled, the interlock key must be inserted into the signal I/O port on the rear before a test starts. See page 163.

Lastly, if Start Click For 1 Second is enabled, it is required to press and hold the START button for 1 second above to initiate a test. Pressing the START button below 1 second will not start a test.

For more information, contact your local dealer or GWInstek at www.gwinstek.com / marketing@goodwill.com.tw.

APPENDIX

Fuse Replacement

Steps

1. Turn the instrument off.

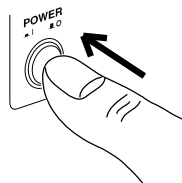

2. Remove the power cord.

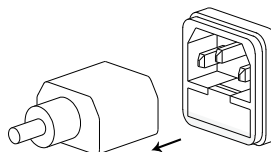

3. Remove the fuse socket using a flat screwdriver.

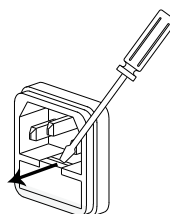

4. Replace the fuse in the fuse holder.

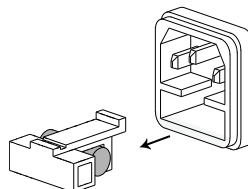

Fuse Rating

T 4A, 250V

Tester Errors

The following test error messages highlighted in red may appear on the GPT-12000 display when completing a running test.

Test Error	Description
HI FAIL	Test result is beyond the HI SET value
LOW FAIL	Test result is below the LOW SET value
V OVER	Measured voltage is beyond the set value by 1.1 times
V LOW	Measured voltage is below the set value by 0.9 time
SHORT	Voltage short-circuit detected
GBI OVER	Measured current is beyond the set value by 1.1 times
GBI LOW	Measured current is below the set value by 0.9 time
GBV OVER	Measured GB voltage is beyond 7.2V
CONT V ERR	Measured CONT voltage is beyond 9.0V
ARC ERR	ARC abnormality detected
GFCI ERR	Ground fault circuit interrupt

The following setup error messages highlighted in red may appear on the GPT-12000 display when abnormality occurs in the settings of MANU steps.

Setup Error	Description
TEST MODE ERROR	Setting error in ACW/DCW
VOLTAGE SET ERROR	Setting error in voltage
CURRENT SET ERROR	Setting error in current
MANU STEP ERROR	Setting error in MANU STEP value
MANU NAME ERROR	Setting error in MANU NAME
HI SET ERROR	Setting error in HI SET value
HISSET <= LOWSET	Set value of HI SET is less than or equal to LOW SET value
HISSET >= ARC	Set value of HI SET is greater than or equal to ARC SET value
LOW SET ERROR	Setting error in LOW SET

TEST TIME ERROR	Setting error in TEST TIME
RAMP TIME ERROR	Setting error in RAMP TIME
ARC FUNC ERROR	Setting error in ARC FUNC
ARC SET ERROR	Setting error in ARC SET
ARC SPEED ERROR	Setting error in ARC SPEED
FREQ SET ERROR	Setting error in FREQ of ACW/GB
WAIT TIME ERROR	Setting error in WAIT TIME
GB CONTACT ERROR	Setting error in GB CONTACT
RAMP DOWN ERROR	Setting error in RAMP DOWN
GROUND ERROR	Setting error in GROUND MODE
MAX HOLD ERROR	Setting error in MAX HOLD
PASS HOLD ERROR	Setting error in PASS HOLD
REF SET ERROR	Setting error in REF VALUE
GBV OVER	Setting Error in $ISET \times (HI SET + REF) > 7.2V$ of GB Mode
INIT VSET ERROR	Setting error in INIT VOLTAGE
IR MODE ERROR	Setting error in IR MODE
DCW OVER 50W	Setting error in $V * I > 50W$ of DCW Mode
GB OVER 200W	Setting error in $V * I > 200W$ of GB Mode
ZERO SET ERROR	Setting Error in ZERO CHECK
CONT. TEST V OVER	Setting Error in $ISET(100mA) \times (HI SET + REF) > 8V$ of CONT Mode
TIME OVER 240s	TIME OVER 240s is displayed when, under ACW test mode, HI SET is greater than 30mA and the RAMP TIME plus the TEST TIME setting is > 240 seconds.
POWER GND FAIL	Power cord fails to connect with earth ground

GPT-12000 Specifications

The specifications apply when the GPT-12000 is powered on for at least 30 minutes at 15°C~35°C.

Specifications

General

DISPLAY	7" color LCD	
MEMORY	AUTO/MANU mode 100 memory blocks total	
POWER SOURCE	AC 100V~240V ± 10%, 50Hz/60Hz	
ACCESSORIES	Power cord x1, Quick Start Guide x1 User Manual x1 (CD) GHT-115 x1 for GPT-12001/2/3 GHT-115 x1, GTL-215 x1 for GPT-12004	
DIMENSIONS & WEIGHT	GPT-12001	Approx.
	GPT-12002 GPT-12003	380(W) x 148(H) x436(D) / 11kg
	GPT-12004	Approx. 380(W) x 148(H) x454(D) / 15kg

Environment

Range	Temperature	Humidity
Warranty	15°C ~ 35°C	≤70% (No condensation)
Operation	0°C ~ 40°C	≤70% (No condensation)
Storage	-10°C ~ 70°C	≤85% (No condensation)
Installation Location	Indoors at an amplitude of up to 2000m.	

AC Withstanding Voltage

Output Voltage Range	0.050kV~ 5.000kV ¹
Output Voltage Resolution	1V
Output Voltage Accuracy	± (1% of setting +5V) with no load
Maximum Rated Load(Table1)	200VA (5kV/40mA)[GPT-12XXX]
Maximum Rated Current	40mA[GPT-12XXX] 0.001mA~10mA(0.05kV≤V≤0.5kV) 0.001mA~40mA(0.5kV<V≤5kV)
Output Voltage Waveform	Sine wave
Frequency	50 Hz / 60 Hz
Voltage Regulation	± (1% +5V)[Maximum rated load →no load]
Voltmeter Accuracy	± (1% of reading+ 5 V)
Current Measurement Range	0.001mA~40.00mA [GPT-12XXX]
Current Best Resolution	1uA 1uA (1uA~9.999mA) 10uA(10.00mA~40.00mA)
Current Measurement Accuracy	± (1.5% of reading+30uA)
Current Offset	60uA Maximum
Judgment Accuracy	± (3% of setting+30uA)
Window Comparator Method	Yes
ARC DETECT	Yes
Rise-time Control Function	Yes
RAMP TIME (Rise Time)	0.1~999.9s
Fall-time Control Function	Yes
RAMP DOWN Time	0.0~999.9s
TIMER (Test Time) ²	OFF, 0.3s~999.9s
TIMER Accuracy	+/- (100ppm+20ms)
GND	ON/OFF
WAIT TIME	0.0~999.9s

¹ At least 0.3 seconds is needed to reach a set voltage of 50V/10mA.

² Timer can only be turned off when the upper current is set below 30mA.

DC Withstanding Voltage

Output Voltage Range	0.050kV~ 6.000kV ¹
Output Voltage Resolution	1V
Output Voltage Accuracy	±(1% of setting +5V) With no load
Maximum Rated Load	50W(5kV/10mA) [GPT-12XXX]
Maximum Rated Current	10mA [GPT-12XXX] 0.001mA~2mA(0.05kV≤V≤0.5kV) 0.001mA~10mA(0.5kV<V≤6kV)
Voltmeter Accuracy	± (1% of reading+ 5 V)
Voltage Regulation	± (1% +5V)[Maximum rated load ->no load]
Current Measurement Range	0.001mA-10.00mA
Current Measurement Best Resolution	0.1μA 0.1μA (0.1μA~999.9μA) 1μA(1μA~9.999mA) 10μA(10.00mA)
Current Measurement Accuracy	±(1.5% of reading+3μA) when I<1mA ±(1.5% of reading+30μA) when I≥1mA
Current Offset	5μA Maximum
Judgment Accuracy	± (3% of setting+30μA)
Window Comparator Method	Yes
ARC DETECT	Yes
Rise-time Control Function	Yes
RAMP TIME (Rise Time)	0.1~999.9s
Fall-time Control Function	Yes
RAMP DOWN Time	0.0~999.9s
TIMER (Test Time)	OFF, 0.3s~999.9s
TIMER Accuracy	+/- (100ppm+20ms)
GND	ON/OFF
WAIT TIME	0.0~999.9s
Maximum Capacitive Load DC Mode	1μF

¹ At least 0.3 seconds is needed to reach a set voltage of 50V/2mA.

Insulation Resistance Test

Output Voltage	50V-1200V	
Output Voltage Resolution	50V	
Output Voltage Accuracy	±(1% of setting +5V) with no load	
Resistance Measurement Range	0.1MΩ~50GΩ	
Test Voltage	Measurement Range	Accuracy
50V≤V≤450V	0.1MΩ~1MΩ	5% of reading + 3 count
	1MΩ~50MΩ	5% of reading + 1 count
	51MΩ~2GΩ	10% of reading + 1 count
500V≤V≤1200V	0.1MΩ~1MΩ	5% of reading + 3 count
	1MΩ~500MΩ	5% of reading + 1 count
	501MΩ~9.999GΩ	10% of reading + 1 count
	10G~50GΩ	20% of reading + 1 count ¹
Test Voltage	Display Range	
50V≤V≤100V	000.1MΩ~10.00GΩ	
150V≤V≤450V	000.1MΩ~20.00GΩ	
500V≤V≤1200V	000.1MΩ~50.00GΩ	
Voltage regulation	± (1% +5V) [Maximum rated load ->no load	
Voltmeter Accuracy	±(1% of reading +5V)	
Resistance Judgment Range	0.1MΩ~50GΩ	
Test Voltage	Judgment Range	Accuracy
50V≤V≤450V	0.1MΩ~1MΩ	5% of setting + 3 count
	1MΩ~50MΩ	5% of setting + 1 count
	51MΩ~2GΩ	10% of setting + 1 count
500V≤V≤1200V	0.1MΩ~1MΩ	5% of setting + 3 count
	1MΩ~500MΩ	5% of setting + 1 count
	501MΩ~9.999GΩ	10% of setting + 1 count
	10G~50GΩ	20% of setting + 1 count ¹
Short-Circuit Current	10mA max.	
Output Impedance	2kΩ	
Window Comparator Method	Yes	
Rise-time Control Function	Yes	
RAMP TIME (Rise Time)	0.1~999.9s	
Fall-time Control Function	Yes	
RAMP DOWN Time	0.0~999.9s	
WAIT TIME	0.0~999.9s	
TIMER (Test Time)	0.3s~999.9s ²	
TIMER Accuracy	+/- (100ppm+20ms)	
GND	ON/OFF	

NOTE: It is required to implement GND OFFSET action when IR Ground Mode is On.

¹ When IR Ground Mode is On, the maximum 30Gohm measurement range is guaranteed.

² When IR Ground Mode is On, test time starts from 0.5 second.

Ground Bond Test

Output Current Range	3.00A~32.00A
Output Current Accuracy	±(1% of setting+0.2A) when 3A≤I ≤8A ±(1% of setting+0.05A) 8A < I ≤ 32A
Output Current Resolution	0.01A
Test Voltage	Approximately max. 8VAC (open-circuit)
Frequency	50Hz/60Hz selectable
Ohmmeter Measurement Range	1mΩ ~ 650mΩ

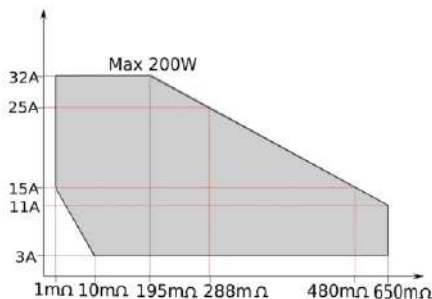

Ohmmeter Measurement Resolution	0.1mΩ
Ohmmeter Measurement Accuracy	±(1% of reading+2mΩ)
Ohmmeter Judgment Accuracy	±(1% of setting+2mΩ)
Window Comparator Method	Yes
TIMER (Test Time)	0.3s~999.9s
TIMER Accuracy	+/(100ppm+20ms)
GND	ON/OFF

Continuity Test

Output Current	100mA(DC)
Ohmmeter Measurement Range	0.10Ω~70.00Ω
Ohmmeter Measurement Resolution	0.01Ω
Ohmmeter Measurement Accuracy	±(10% of reading+2Ω)
Ohmmeter Judgment Accuracy	±(10% of setting+2Ω)
Window Comparator Method	Yes
TIMER (Test Time)	0.3s~999.9s
TIMER Accuracy	+/(100ppm+20ms)

Interface

REMOTE (Remote terminal)	Yes
SIGNAL IO	Yes
RS232	Yes
USB (Device)	Yes (USB 2.0)
Rear Output	Yes
USB (Host) for data output port	Yes (USB 2.0)
GPIB	Yes (Optional)

Table 1: Output Limitation in Withstanding Voltage Testing

Function	Upper Current	Pause	Output Time
AC	$30\text{mA} \leq I \leq 40\text{mA}$	At least as long as the output time	Maximum 240 seconds
	$0.001\text{mA} \leq I < 30\text{mA}$	Not necessary	Continuous output possible
DC	$0.001\text{mA} \leq I \leq 10\text{mA}$	Not necessary	Continuous output possible
GB	$15\text{A} < I \leq 32\text{A}$	At least as long as the output time	999.9 seconds
	$3\text{A} \leq I \leq 15\text{A}$	Not necessary	999.9 seconds

NOTE: Output Time = Ramp Time + Test Time.

Table 2: GPT-12000 capacitive load table

	Test Voltage DCW	Test Condition HI-SET Current	RAMP Time ↗	Maximum Capacitive Load
1	1.000kV	$I \geq 10.00\text{mA}$	$T \geq 1.0\text{S}$	4.7uF
2	2.000kV	$I \geq 7.00\text{mA}$	$T \geq 1.0\text{S}$	1.65uF
3	3.000kV	$I \geq 8.00\text{mA}$	$T \geq 1.0\text{S}$	1.32uF
4	4.000kV	$I \geq 11.00\text{mA}$	$T \geq 1.0\text{S}$	1.32uF
5	5.000kV	$I \geq 7.00\text{mA}$	$T \geq 1.0\text{S}$	0.66uF
6	6.000kV	$I \geq 8.00\text{mA}$	$T \geq 1.0\text{S}$	0.66uF

GPT-12001/12002/12003 Dimensions

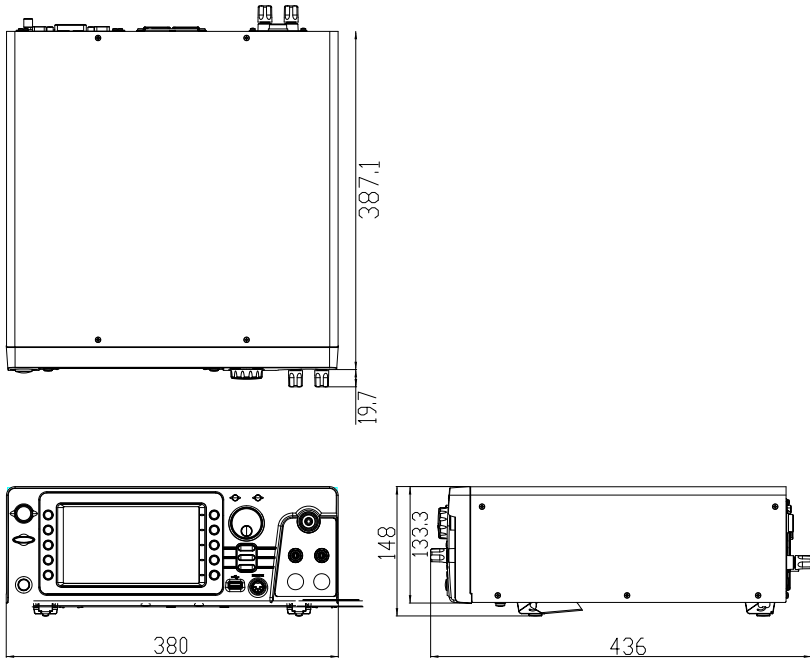

GPT-12004 Dimensions

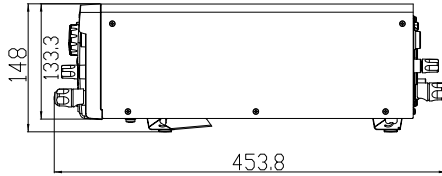
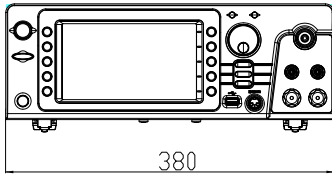
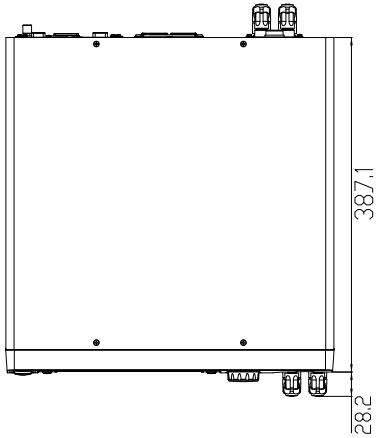

Declaration of Conformity

We

GOOD WILL INSTRUMENT CO., LTD.

declare that the below mentioned product

Type of Product: Electrical Safety Analyzer

Model Number: **GPT-12001 / GPT-12002/ GPT-12003 / GPT-12004**

satisfies all the technical relations application to the product within the scope of council:

Directive: 2014/30/EU; 2014/35/EU; 2011/65/EU; 2012/19/EU

The above product is in conformity with the following standards or other normative documents:

© **EMC**

EN 61326-1:	Electrical equipment for measurement, control and laboratory use -- EMC requirements (2013)	
EN 61326-2-1:		
Conducted & Radiated Emission EN 55011: 2016+A1:2017 Class A	Electrical Fast Transients EN 61000-4-4: 2012	
Current Harmonics EN 61000-3-2: 2014	Surge Immunity EN 61000-4-5: 2014	
Voltage Fluctuations EN 61000-3-3: 2013	Conducted Susceptibility EN 61000-4-6: 2014	
Electrostatic Discharge EN 61000-4-2: 2009	Power Frequency Magnetic Field EN 61000-4-8: 2010	
Radiated Immunity EN 61000-4-3: 2006+A2:2010	Voltage Dip/ Interruption EN 61000-4-11: 2004	

© **Safety**

Low Voltage Equipment Directive 2014/35/EU	
Safety Requirements	EN 61010-1: 2010 EN 61010-2-030: 2010 EN 61010-2-034: 2017

GOOD WILL INSTRUMENT CO., LTD.

No. 7-1, Jhongsing Road, Tucheng Dist., New Taipei City 236, Taiwan

Tel: +886-2-2268-0389

Fax: +866-2-2268-0639

Web: www.gwinstek.com

Email: marketing@goodwill.com.tw

GOOD WILL INSTRUMENT (SUZHOU) CO., LTD.

No. 521, Zhujiang Road, Snd, Suzhou Jiangsu 215011, China

Tel: +86-512-6661-7177

Fax: +86-512-6661-7277

Web: www.instek.com.cn

Email: marketing@instek.com.cn

GOOD WILL INSTRUMENT EURO B.V.

De Run 5427A, 5504DG Veldhoven, The Netherlands

Tel: +31(0)40-2557790

Fax: +31(0)40-2541194

Email: sales@gw-instek.eu

INDEX

- Accessories 12
- Automatic test
 - add test97
 - load95
 - page view 99, 101
 - results 112
 - running a test106
 - test file name96
- Caution symbol 5
- Cleaning the instrument 7
- Declaration of conformity 243
- Dimensions241, 242
- Disposal instructions 8
- EN61010
 - measurement category7
 - pollution degree8
- Environment
 - safety instruction7
- External control 158
 - Interlock key 164
 - overview159
 - remote operation160
 - remote terminal 159
 - signal I/O operation 163
 - signal I/O overview161
- FAQ230
- Front panel diagram 14
- GPIB installation 23
- Ground
 - symbol5
- Interlock key 164
- Line voltage selection 22
- List of features 11
- Manual tests
 - ARC mode58
 - fail mode54, 63
 - ground mode72
 - max hold61
 - overview38
 - pass hold62
 - ramp up time 46, 48, 56
 - results83
 - running a test78
 - special mode 89, 91
 - test filename 41
 - test frequency 52
 - test function 39
 - test limits42
 - test reference53
 - test selection 40
 - test time44
 - test voltage50
 - timing diagrams 84
- Marketing
 - contact 231
- Menu tree30
- Operating precautions25
- Overview10
- Package contents 13
- Power on/off
 - safety instruction7
- Rear panel diagram 18
- Remote control 165
 - Command list 173
 - Command syntax170
 - function check168
 - interface configuration 166
- Service operation
 - about disassembly 6
 - contact 231
- Specifications 235
- Test errors233
- Tilt stand 21
- Utility settings
 - buzzer 121
 - Control settings125, 139, 143, 146, 147, 149
 - double action125, 139, 143, 146, 147, 149
 - GPIB 123
 - interface 123
 - key lock 125, 139, 143, 146, 147, 149
 - LCD 119
 - RS232 123

start control	125, 139, 143, 146, 147, 149	Workplace precautions24
USB123	Zeroing 65, 67, 69, 76, 154
Warning symbol 5		